

Solution Provider for Interconnection Technologies

www.NextronGroup.com



Taipei, Taiwan, Headquarter

2F, No.31, Lane 169, Kang Ning Street,
Hsi Chih District, New Taipei City, Taiwan, R.O.C.
TEL: +886-2-6616-2000
FAX: +886-2-8695-1177
E-mail: sales@nextron.com.tw
www.NextronGroup.com

Taipei, Taiwan, Factory

1F, No.5, Lane 169, Kang Ning Street,
Hsi Chih District, New Taipei City, Taiwan, R.O.C.
TEL: +886-2-6616-2000
FAX: +886-2-8695-1177

Guangzhou, China, Factory

No.24, Guanyong Village, Shilian Highway, Shiji
Town, Panyu District, Guangzhou City,
Guangdong Province, China
Zip Code : 511450
TEL: +86-20-8455-1166
FAX: +86-20-8455-1168



© 2024 / 03 NEXTRONICS ENGINEERING CORP.

nextron



Circular Connector Solution



- Plastic SnapLatch Series
- Metal T SnapLatch Series
- Metal S SnapLatch Series
- Metal B SnapLatch Series
- Metal K SnapLatch Series
- Micro Series



ISO 9001
ISO 45001
ISO 13485
IATF 16949
ISO 50001
AS 9100
ISO 14064
ISO 14001
TL9000
ISO 14067

Index

Company Profile	03
Customization Solutions	07
Property	11
Product Series	13
Product Options	15
Standard Product	18
Accessories	50
Tools	52
Appendix	53

1P Series^{P.18}

2P Series^{P.29}

B Series^{P.36}

T Series^{P.42}

K Series^{P.44}

S Series^{P.48}

Micro Series^{P.49}



About Nextron

Company Profile



Solution Provider

Nextron has its unique technologies in high speed, press-fit, thermal and locking mechanism with over 30 years experiences to provide interconnection solution for the customer who is in need of the telecom, datacom, medical, energy and embedded system.

Three Business Units

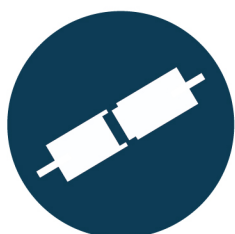

Interconnection

- High-Speed I/O Connectors
- Plastic / Metal Circular Connectors
- High-Current Connectors
- Backplane Connectors



System Integration

- Mechanical Components
- PICMG Standard Subsystems
- ATX & Mini ITX Subsystems



Thermal Solutions

- Heat Fin/ Heat Pipe/ Thermal Plate Design and Manufacturing
- System-wide Thermal Simulation
- Fanless Chassis Thermal Design

About Nextron

Core Technology

Integrated Technology



Utilize Nextron's unique integrated technology and customization service to create value added service in order to solve customer's pain.

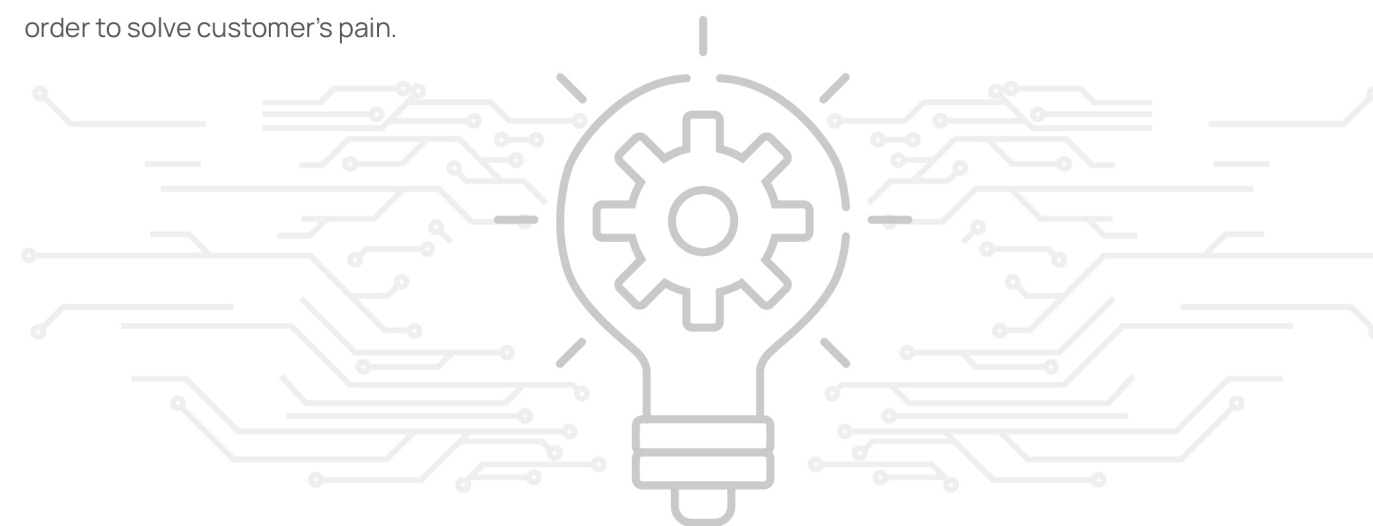

Nextron creates unique solutions tailored to each customer's needs through SOLIDWORKS and Nextron Interconnection Design. We focus on the detail of our product quality and continue to exceed more existing standards.



Medical

Aerospace

Transport

Industry

Cloud /
Communication

Nextron participates the International standard association (SFF&CDFP) and academic institution (High Speed Connections Joint Lab). Such as obtaining the relevant technical specifications and development trends. Nextron also spares no effort to strengthen its technical energy and personnel cultivation.

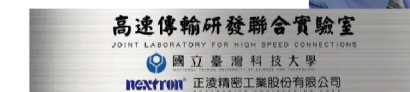

Nextron Quality

Testing Capability



- National Standard
- Industry Standard
- Customer's Requirement

Complete equipped lab and ally with certified laboratory (ISO-17025) . Verify product specification through development stages based on national and industrial standard .

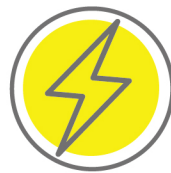

Electrical

- EMI Test
- Contact Retention
- Electrostatic Breakdown
- High-speed Signal



Material

- Durability
- Metal Bending Strength
- X-Ray
- Insertion Force



Environment

- Steam Aging
- Salt Spray
- Temperature Life
- Thermal Shock
- Heat Resistance



Measurement

- Side Force
- Solder Ability
- 3D Measurement
- Film Thickness Test

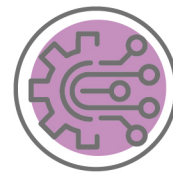

Mechanical

- Drop Test
- Spring Force
- Random Vibration

Certification

Nextron provides the most reliable products for our customers with a worldwide quality standard system.



Nextron Core Technology

Simulation

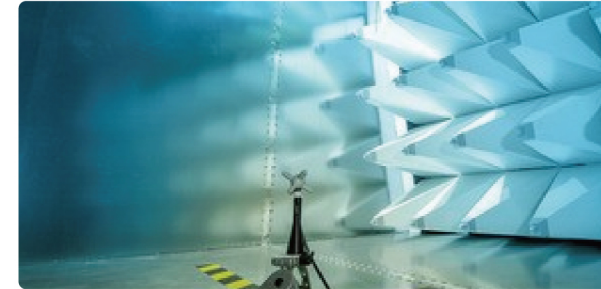

EMI Tester Lab

Antenna polarization matching equidistant transmission and reception.

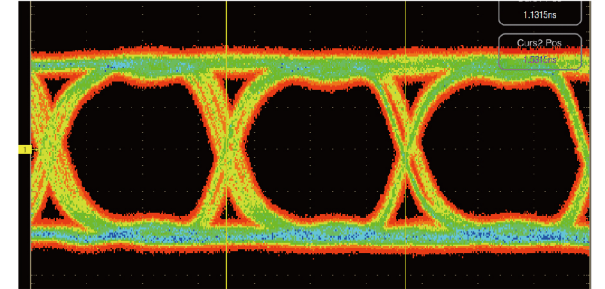

High speed Measurement

Measuring the electrical characteristics of the products material.

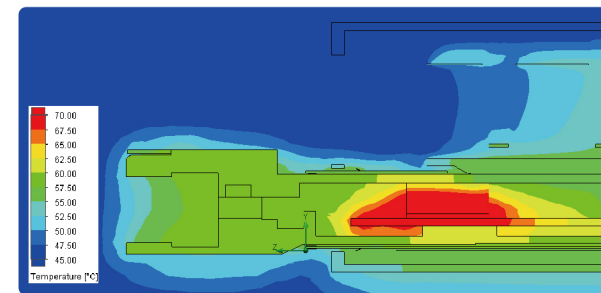

Thermal analysis

- Using simulation environment similar to customer's.
- Custom design for customer's cooling requirements.

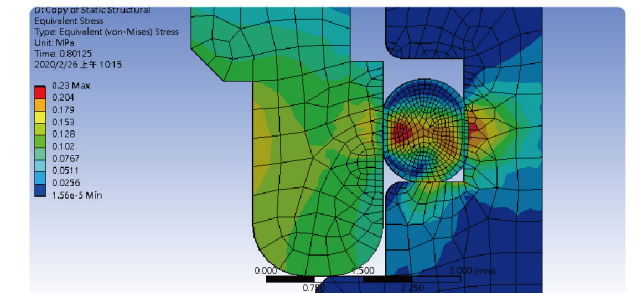

FEA & Mechanical analysis

- Through product design and simulation to increase the success rate.
- Test & optimize all kinds of mechanical forces
- Apply solutions for stress

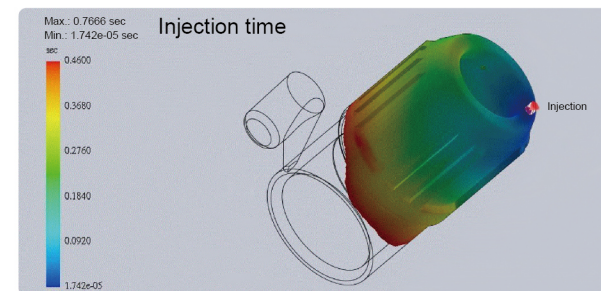

Mold flow analysis

Using the analyzed data plus the experience of design and manufacturing production cases, to provide customer molding related demand services and follow-up problem countermeasures

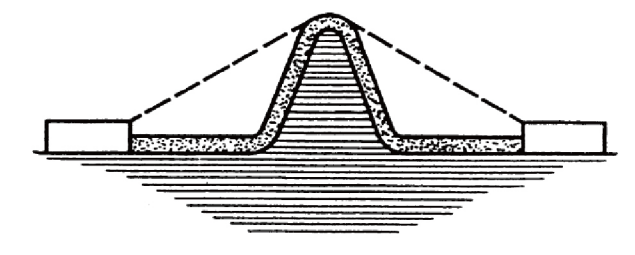

Insulation

- clearance, Creepage & Withstand voltage
- Familiar the specification
- Products comply with standards (IEC 60664-1)
- Ensure the electrical performance

Customized Solutions

Optimized Customization Services

Nexttron offers interconnection customization services and connectors. The customization can be the simple way to make a brand new connector design from our standard series.

Nexttron can not just only help you to achieve the target performance function wise but also think of the optimized way in terms of cost, manufacturing even post process.

Outer Shell

Diagram showing six customization options for the outer shell of a connector, each with an icon and a label:

- Lightweight**: Icon of a feather.
- Robust**: Icon of a muscular person.
- One Piece**: Icon of a single circular piece.
- Biocompatibility**: Icon of a medical cross and a leaf.
- Outshell Design**: Icon of a seashell.
- Waterproof**: Icon of a water drop with 'IP' below it.



Insulator & Contact

Diagram showing six customization options for the insulator and contact, each with an icon and a label:

- High Speed Signal**: Icon of a DNA double helix.
- Fluidic**: Icon of a network of pipes.
- Pin Contact : Coaxial / Pogo / Flex-pin / Four Points**: Icon of a pin being inserted into a socket.
- High Density 200 /pin**: Icon of a circular array of pins labeled 'MAX' and '200 /pin'.
- Designated Mating Cycle**: Icon of a plug and socket.
- High Power : Current / Voltage**: Icon of a lightning bolt.

Customized Locking

Diagram showing a padlock icon and a list of locking mechanisms:

- Screw
- Push-Pull
- Break-away
- Bayonet
- Double Floating Ratchet
- Bidirectional Release

Customized Solutions

High Speed Signal

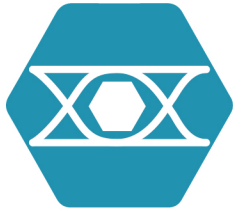

Nextron can provide customers with the most suitable option from the choice of material dielectric constant to the signal simulation and measurement of products according to customers' needs for high-speed transmission. We used CST Suite Software for electromagnetic simulation analysis, combined with plastic high-frequency material measurement data that has accumulated many years of experience, which can significantly reduce the gap between product design performance and simulation in order to accelerate the production speed.

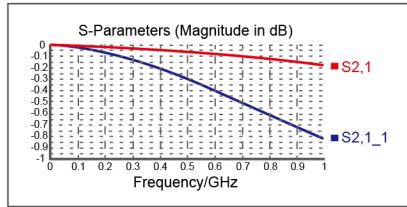

Insertion Loss

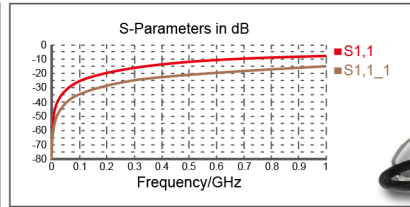

Return Loss



Anti-Vibration



Nextron designs double floating ratchet method for a variety of vibration environments ranging from automobile, train, aerospace system, oil drilling equipment, power station and manufacturing plant. It can pass Apache helicopter Test Standard (MIL-STD 810F) with silicone clip solution.

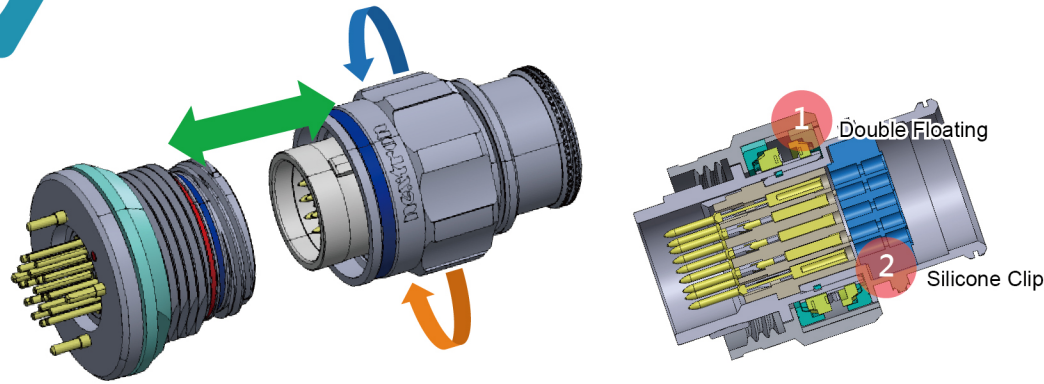

High Density



Nextron design (Patent number: Y310000090) the hand piece sized connector to simplify user's work. For example, the next generation catheter system. The user can contact 200 pin (O.D. 25mm size) easily and directly when plug-in the socket.

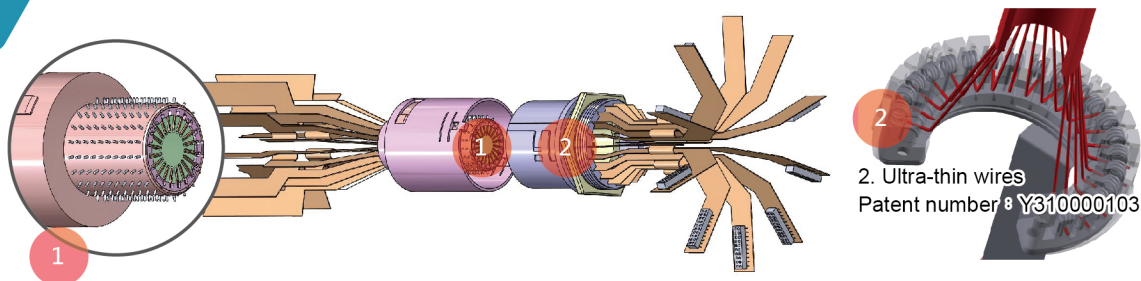

Hybrid Contacts



Nextron can provide customized connectors with multifunctional contacts. We use our knowledge in higher current material and control the size of power contact whilst considering the derating factor for multiple contacts. We also take creepage and clearance into account, trying to provide a safety connector.

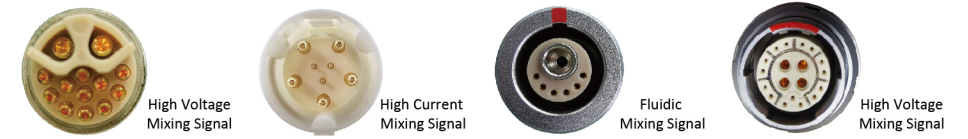

Contact Type



Nextron provides diversified contacts to fit customized design and a variety of different requirements.

Contacts				
	Coaxial Contacts	Pogo Contacts	Four Points Contacts	Fluidic Contacts
Advantages	<ul style="list-style-type: none"> • Good Resistance to EMI • Good Performance on RF Solution 	<ul style="list-style-type: none"> • Design Flexibility • High Lifetime • Small Size 	<ul style="list-style-type: none"> • High-Density • High-Reliability 	<ul style="list-style-type: none"> • Fluidic Use

Locking Solution



Nextron develops methods to make mating easier, more ergonomic.



Locking Method					
	Push-Pull	Bayonet	Bidirectional Release	Break-away	Double Floating Ratchet
Product Series	P / B / K / S / T Series	Iguana Series	Chameleon Series	Gecko Series	Hermes Series
Advantages	<ul style="list-style-type: none"> • Easy mating and separating • Blind mating 	<ul style="list-style-type: none"> • Mating Faster • Long Threaded Cap Cycle Life 	<ul style="list-style-type: none"> • Bidirectional Releasing System 	<ul style="list-style-type: none"> • Quick Release 	<ul style="list-style-type: none"> • Anti-Vibration

Designated Mating Cycle

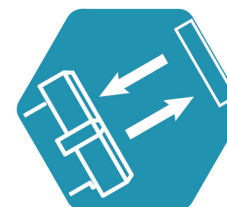

Nextron has a proprietary design, we can limit the circular push-pull connector mechanical mating cycles. The connector mating function would be disabled after a specific mating cycle to make sure the connector is not overused. For instance, we can provide one-time mating cycle to three or more designated mating cycles.

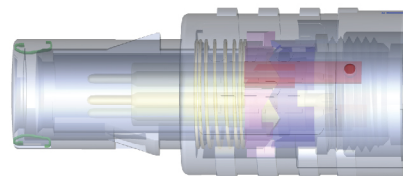

Property

Metal

Item	Temperature	Density (g/cm ³)	Electrical	Sterilization	Machinability	Strength	Dielectric Properties	Temperature resistance	Corrosion resistance	Lightweight	Main attributes
Copper alloy	-100~200°C	8.3~8.9	●		●				●		Excellent electrical and thermal conductivity
SUS	-100~350°C	7.93~7.98				●		●	●		Corrosion resistance, Hard and strong
Zinc alloy	-100~200°C	6.4~6.5	●	●	●	●		●	●		Excellent corrosion resistance, impact strength
Aluminum alloy	-100~200°C	2.7	●			●	●	●		●	Lightweight & Structural material

Plastic ★ Excellent ● Good

Item	Temperature	RTI	Electrical	Sterilization	Machanical	Strength	Dielectric strength	Temperature resistance	Biocompatibility	Chemicals resistance	Main attributes
PEEK	-55~220°C	220	●	●	★	★	●	★		★	Hospital Cleaner Resistant, permanent implant grades, sterilization, high temperatures
PPSU	-50~160°C	160	●	●				●	●	●	Hospital Cleaner Resistant, sterilization, good dimensional stability
PEI	-50~170°C	170	●	●		★	●	●	●		Excellent chemical resistance, natural flame resistance, food contact acceptable
PSU	-50~150°C	150	●	●	★	★		●	●	●	Hospital Cleaner Resistant, sterilization, good mechanical properties
LCP	-50~180°C	130	●	●	●		●	●		●	Good Weatherability, Outstanding Mechanical Properties at High Temperatures
PBT	-65~130°C	130			●	●				●	Electrical insulation, low tendency to creep
PC	-50~120°C	120	●	●			●				Hospital Cleaner Resistant, high impact strength, exceptional clarity.

Oring

Item	Temperature	Oils Resistance	Temperature Resistance	Tear Resistance	Abrasion Resistance	Chemical Resistance	Steam Resistance	Main attributes
VMQ	-100~300°C		●		●	●	●	Temperature resistance, non-toxic and insulation performance
FKM	-40~275°C	●	●	●	●	●	●	Custom compounds improve chemical and low-temperature resistance.
EPDM	-55~150°C		●	●	●	●	●	Ozone, drug, alcohol and ketones, aging resistance, Abrasion resistance

Compatibility with sterilization methods

Item	EtO gas	Radiation	Gamma & X-rays	Vaporized Hydrogen Peroxide	Steam	Isopropyl Alcohol
PSU	●			●	●	●
PEI	●			●	●	●
PPSU	●	●		●	●	●
LCP	●			●	●	●
PEEK	●	●		●	●	●
PC	●			●		●

Notice: For PSU cleaning solution, do not use any detergent contains Aromatic Hydrocarbons, Ketones, Esters and Chlorinated Hydrocarbons. The four chemicals will cause rupture or dissolution to PSU material. We recommend to use Isopropyl Alcohol as the chemical cleaner. We recommend to use VTVC-6 Clear Vibra-tite or Threebond 1401 to secure the connector backnut.

Property

IP (Ingress Protection) Ratings Guide

	1	2	3	4	5	6
SOLIDS	<p>Protected against a solid object greater than 50 mm such as a hand.</p>	<p>Protected against a solid object greater than 12.5 mm such as a finger.</p>	<p>Protected against a solid object greater than 2.5 mm such as a screwdriver.</p>	<p>Protected against a solid object greater than 1 mm such as a wire.</p>	<p>Dust Protected. Limited ingress of dust permitted. Will not interfere with operation of the equipment. Two to eight hours.</p>	<p>Dust tight. No Ingress of dust. Two to eight hours.</p>
WATER	<p>Protected against vertically falling drops of water. Limited ingress permitted.</p>	<p>Protected against vertically falling drops of water with enclosure tilted up to 15 degrees from the vertical. Limited ingress permitted.</p>	<p>Protected against sprays of water up to 60 degrees from the vertical. Limited ingress permitted for three minutes.</p>	<p>Protected against water splashed from all directions. Limited ingress permitted.</p>	<p>Protected against jets of water. Limited ingress permitted.</p>	<p>Water from heavy seas or water projected in powerful jets shall not enter the enclosure in harmful quantities.</p>

7 Protection against the effects of immersion in water between 15 cm and 1 m for 30 minutes.

8 Protection against the effects of immersion in water under pressure for long periods.

9k Withstands hot steam flushing tests as defined in EN 60529 and DIN 40050-9. This provides protection at a water pressure of 100 bar (1450 psi) and a temperature of 80 °C.

Rating Example: IP69K
INGRESS PROTECTION

Locking Solutions Push-Pull Self-Latching System

Easy and quick mating & unmating self-latching mechanism is suitable for connection against vibration, shock and pull on the cable in a limited space allowed. The push-pull self-latching system also saves time in mating and unmating comparing to common threaded circular connectors in the market. Nextron circular connection systems also offer a variety of products in material, color, keying, and custom design services.

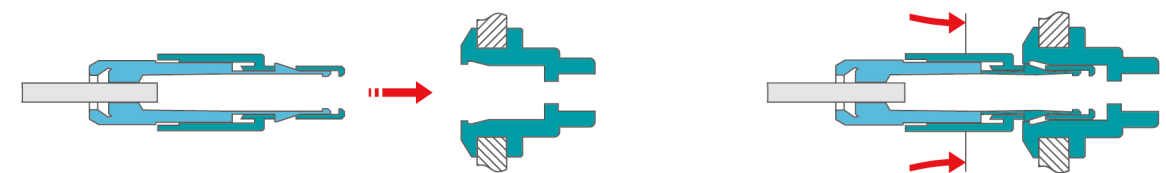

1. The push-pull locking system is widely used for quick and easy mating and unmating.

2. The mating between the connector is simply pushing the plug into the socket.

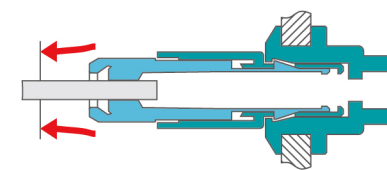

3. Once the connectors are mated, they cannot be unmated by pulling one the parts other than the release sleeve of the outer shell.

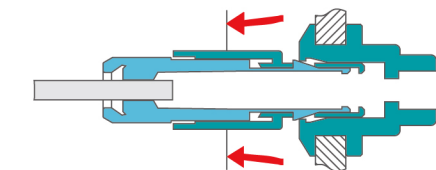

4. To unmate the connectors, simply pull the release sleeve of the outer shell.

Product Series

Push-Pull



Plastic SnapLatch 1P Series

- Multipole 2 to 14 contacts
- Solder cup, print contacts
- IP50 / IP64 / IP67
- Current rating: 2 to 10A
- Insulation resistance: $10^{12}\Omega$
- Dielectric with standing voltage: 0.6 to 1.2kV AC RMS
- Cable diameter: $\varnothing 2.7\text{mm}$ to 6.5mm
- Durability: >2000 cycles

Push-Pull



Plastic SnapLatch 2P Series

- Multipole 2 to 34 contacts
- Solder cup, print contacts
- IP50
- Current rating: 1.5 to 30A
- Insulation resistance: $10^{12}\Omega$
- Dielectric with standing voltage: 0.7 to 1.5kV AC RMS
- Cable diameter: $\varnothing 3.2\text{mm}$ to 9.2mm
- Durability: >1000 cycles

Push-Pull



Metal SnapLatch K Series

- Multipole 2 to 32 contacts
- Solder cup, print & crimp contacts
- 3 Sizes 0K, 1K, 2K
- IP66 / IP68
- Current rating: 1.5 to 25A
- Insulation resistance: $10^{12}\Omega$
- Dielectric with standing voltage: 0.6 to 2.4kV AC RMS
- Cable diameter: $\varnothing 1.0\text{mm}$ to 8.5mm
- Durability: >5000 cycles

Push-Pull



Metal SnapLatch S Series

- Multipole 2 to 4 contacts
- Half-moon insulator
- Solder cup, print & crimp contacts
- IP50
- Current rating: 2.5 to 10A
- Insulation resistance: $10^{12}\Omega$
- Dielectric with standing voltage: 0.9 to 1.1kV AC RMS
- Cable diameter: $\varnothing 1.3\text{mm}$ to 4.4mm
- Durability: >5000 cycles

Push-Pull



Metal SnapLatch B Series

- Multipole 2 to 32 contacts
- Solder cup, print & crimp contacts
- 4 Sizes 00, 0B, 1B, 2B
- IP50
- Current rating: 1.5 to 25A
- Insulation resistance: $10^{12}\Omega$
- Dielectric with standing voltage: 0.6 to 2.4kV AC RMS
- Cable diameter: $\varnothing 0.8\text{mm}$ to 9.9mm
- Durability: >5000 cycles

Push-Pull



Metal SnapLatch T Series

- Multipole 2 to 32 contacts
- Solder cup, print & crimp contacts
- 4 Size TT, 0T, 1T, 2T
- IP 67
- Current rating: 1.5 to 25A
- Insulation resistance: >1000M Ω
- Dielectric with standing voltage: 0.8 to 2.1kV AC RMS
- Cable diameter: $\varnothing 2.4\text{mm}$ to 8.5mm
- Durability: >3000 cycles

Break-away



Micro Series

- Resisting vibration and shock
- Up to 12 Flex-pin
- Solder cup, print contacts
- IP50
- Current rating: 3 amps max
- Insulation resistance: 26m Ω max
- Dielectric with standing voltage: 600V AC RMS
- Cable diameter: $\varnothing 1.3\text{mm}$ to 4.4mm
- Durability: >500 cycles

Product Options

Plastic SnapLatch

Plastic SnapLatch 1P / 2P Series

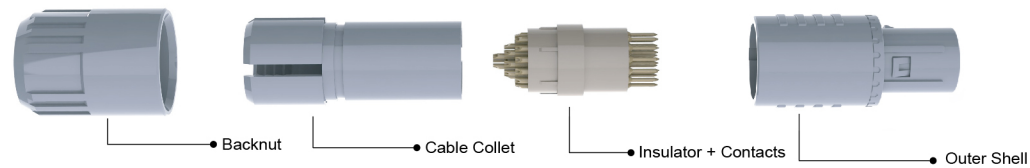

Plastic 1P - Basic Type

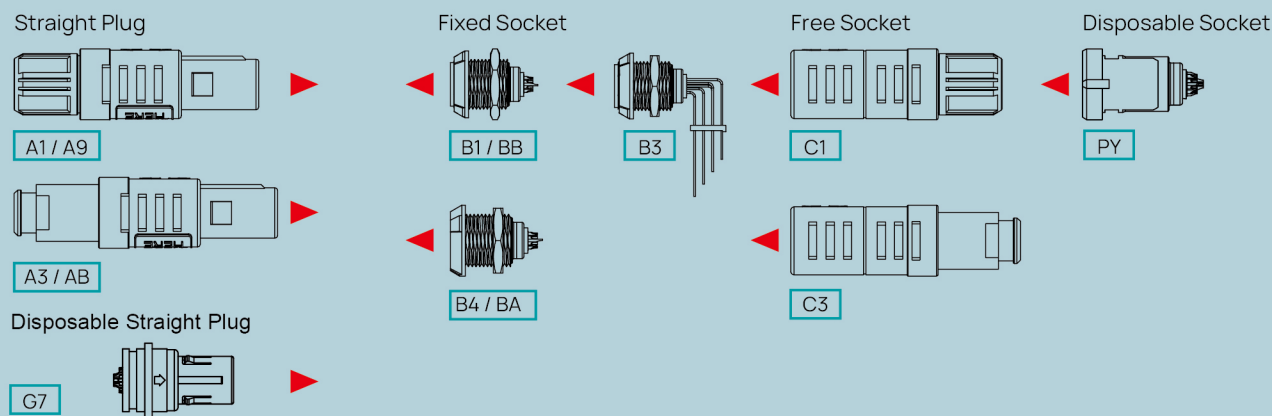

Plastic 1P - Fluidic

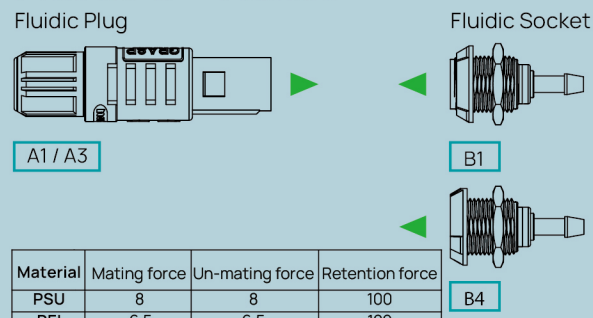

Material	Mating force	Un-mating force	Retention force
PSU	8	8	100
PEI	6.5	6.5	120

Note
 1. 1N= 0.102kg
 2. Forces were measured on outer shell not fitted with contact.
 3. Except plastic 1P basic type disposable socket.

Plastic 1P - Watertight

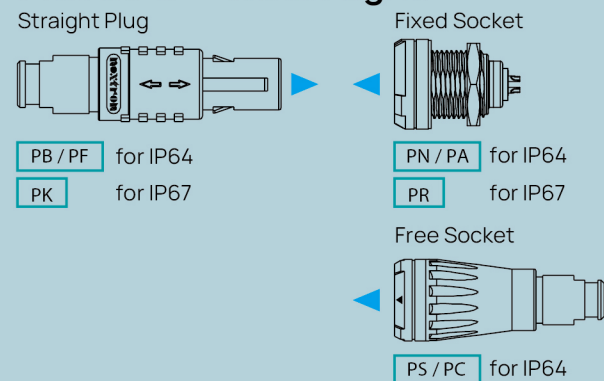

Plastic 2P - Basic Type

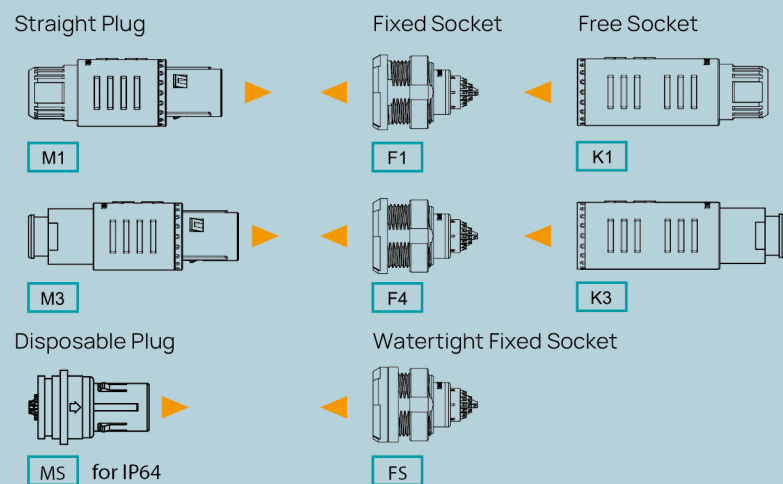

Plastic 2P - Coaxial

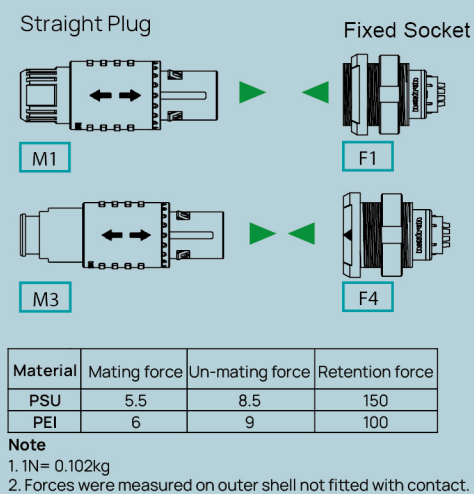

Material	Mating force	Un-mating force	Retention force
PSU	5.5	8.5	150
PEI	6	9	100

Note
 1. 1N= 0.102kg
 2. Forces were measured on outer shell not fitted with contact.

▶ + ◀ Same Color = Match

Product Options

Metal SnapLatch

Metal SnapLatch B Series

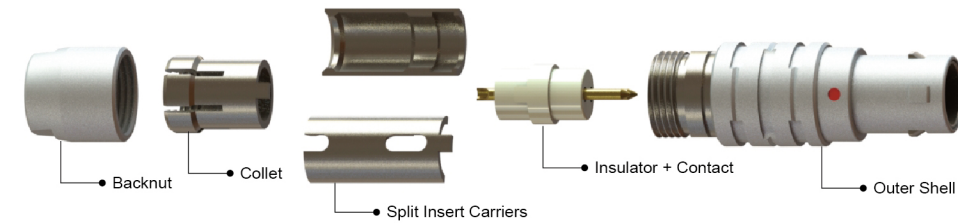

Metal B- Basic Type

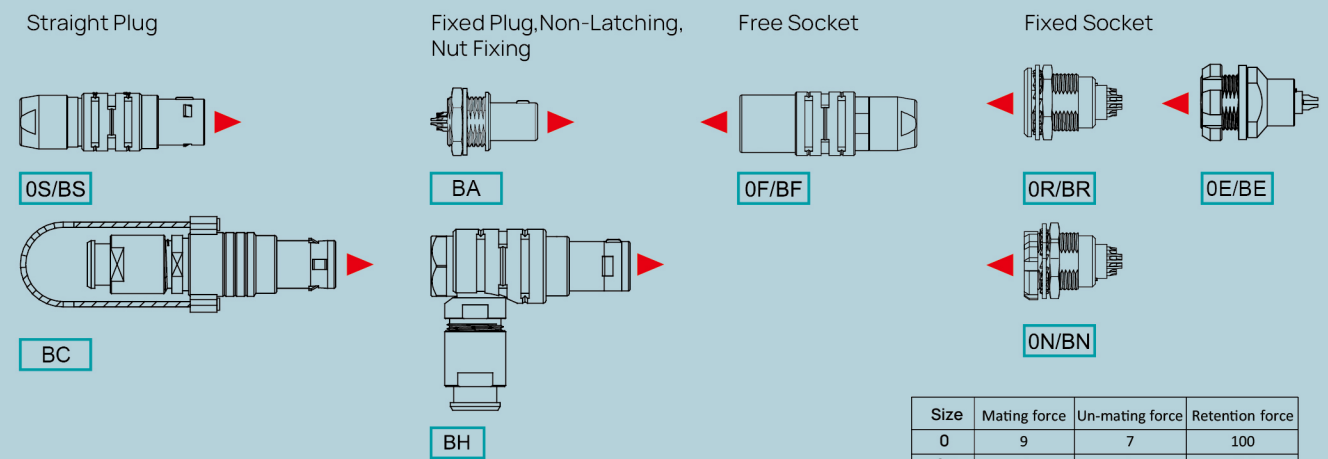

Size	Mating force	Un-mating force	Retention force
0	9	7	100
0B	10	8	180
1B	14	11	300
2B	15	12	300

Note
 1. 1N = 0.102kg
 2. Forces were measured on outer shell not fitted with contact.

Metal SnapLatch T Series

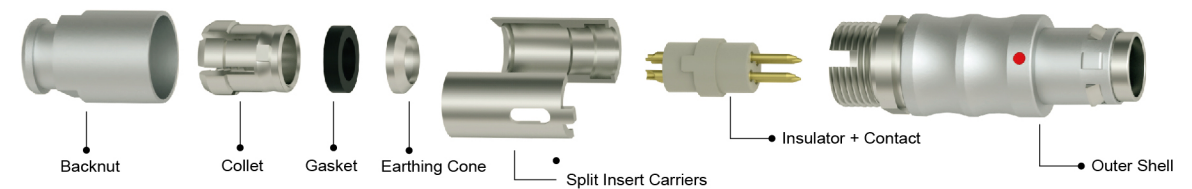

Metal T- Basic Type

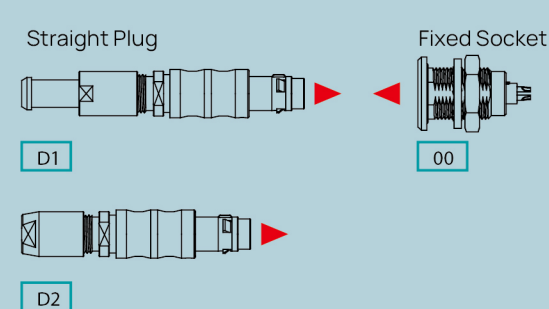

Size	Mating force	Un-mating force	Retention force
TT	14	12	80
0T	15	13	130
1T	16	14	250
2T	20	15	250

Note
 1. 1N = 0.102kg
 2. Forces were measured on outer shell not fitted with contact.

▶ + ◀ Same Color = Match

Product Options

Metal SnapLatch

Metal SnapLatch K Series

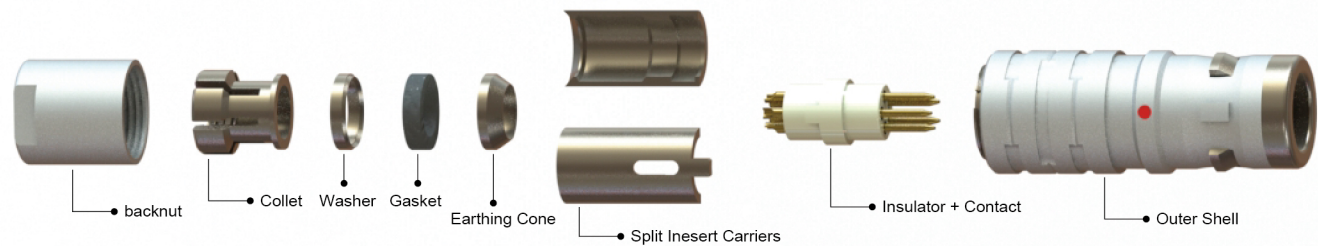

Basic Type

Straight plug

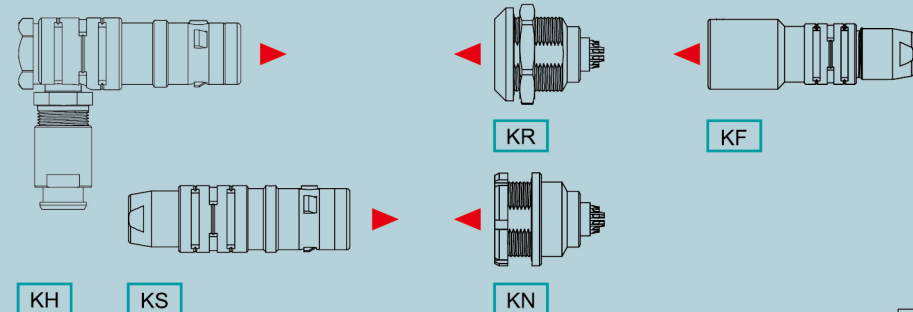

Size	Mating force	Un-mating force	Retention force
0K	14	9	250
1K	16	10	300
2K	20	13	400

Note
 1. 1N = 0.102kg
 2. Forces were measured on outer shell not fitted with contact.

Metal SnapLatch S Series

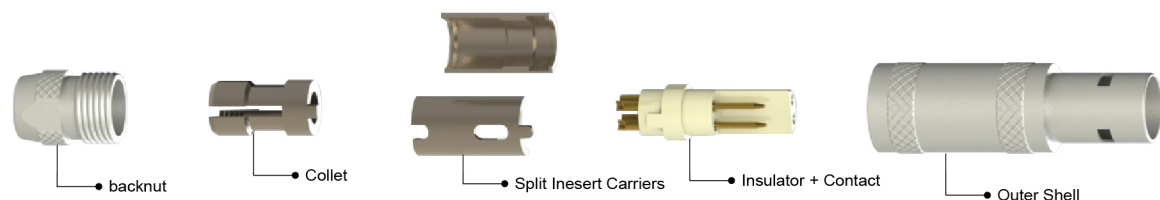

Basic Type

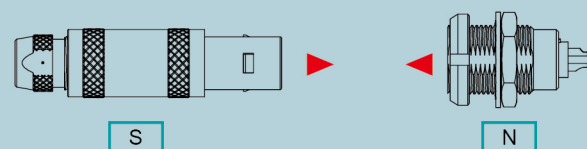

Size	Mating force	Un-mating force	Retention force
0S	14	9	140

Note
 1. 1N = 0.102kg
 2. Forces were measured on outer shell not fitted with contact.

Plastic 1P Series

SnapLatch Straight Plug

1P Series

Features

- Locking system: Push-Pull
- Multipole 2 to 14 contacts
- Solder cup, print contacts
- Touch & scoop proof
- Multiple key options to avoid cross mating
- Cable diameter: Ø2.7mm to 6.5mm
- Color coded nut: Black, White, Red, Yellow, Green, Blue, Grey

Technical Data

- Material**
- Outer shell and back nut : PSU/PEI UL 94V-0
 - Insulator : polyetheretherketone UL 94V-0(Peek)
 - Contact : Copper alloy plating Au
- Environmental**
- IP50 when mated
 - Working temp.: PSU : -50°C~+150°C
 - PEI : -50°C~+170°C
- Mechanical**
- Mating cycle : > 2000 cycles

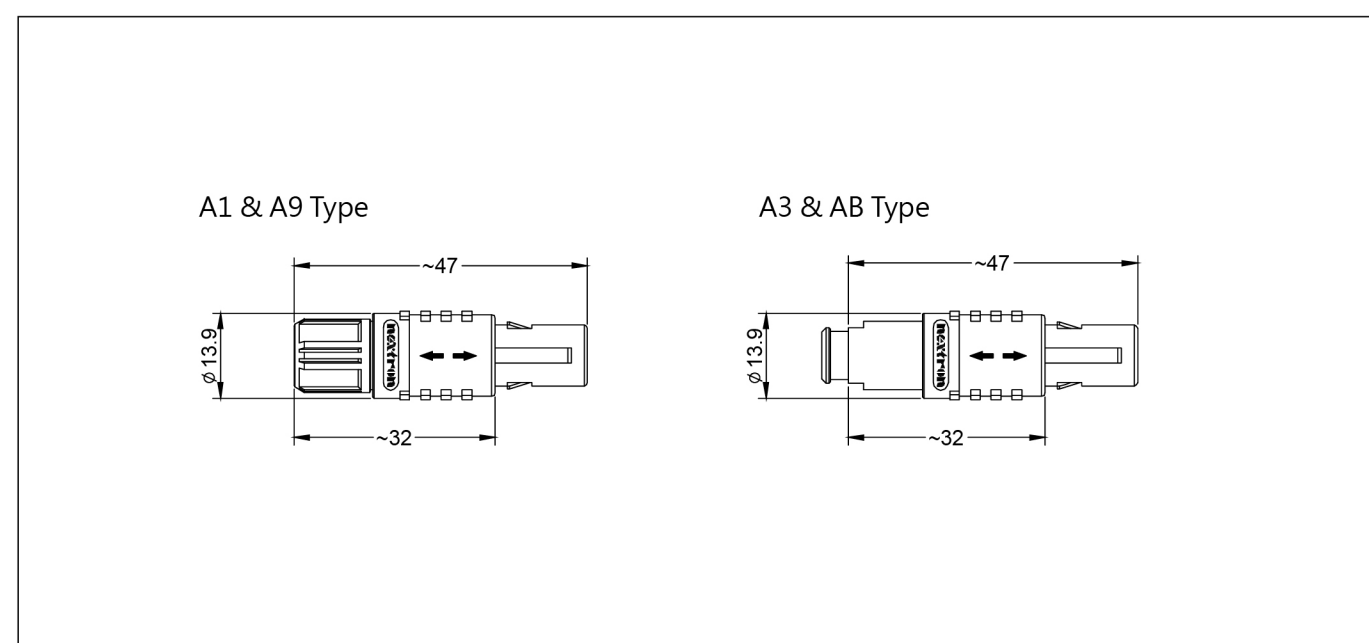

Unit : Millimeters. Dimensions for reference only.

Part Number & Spec. Description

R M * * * * P * 2 * * * * 0

STYLE
 A1= Straight plug, male solder contact, standard back nut.
 A3= Straight plug, male solder contact, bend relief back nut.
 A9= Straight plug, female solder contact, standard back nut.
 AB= Straight plug, female solder contact, bend relief back nut.

OUTER SHELL MATERIAL
 G=Grey PSU F=Black PEI
 B=Black PSU P=Grey PEI

BACK NUT COLOR
 0= Black 2= RED 5= Green 8= Grey
 1= White 4= Yellow 6= Blue

CONTACT DIAMETER
 1= 1.3mm (only for 2, 3 contacts) 3= 0.7mm (only for 6, 7, 8 contacts)
 2= 0.9mm (only for 4, 5 contacts) 4= 0.5 mm (only for 9, 10, 12, 14 contacts)

NUMBER OF CONTACTS
 02=2 contacts 06=6 contacts 10=10 contacts
 03=3 contacts 07=7 contacts 12=12 contacts
 04=4 contacts 08=8 contacts 14=14 contacts
 05=5 contacts 09=9 contacts

ALIGNMENT KEY
 0=0°
 --*
 J=205°

CABLE COLLET
 1=Ø 3.9mm (Cable Ø=2.7~3.9mm)
 2=Ø 5.2mm (Cable Ø=4.0~5.2mm)
 3=Ø 6.5mm (Cable Ø=5.3~6.5mm)

Note 1. Back nut material is same as outer shell.
 Note 2. Insert configuration & operating voltage, please see page 53. **A**
 Alignment key, please see page 54. **B**
 Note 3. Cable O.D, please see page 56. **E**

Plastic 1P Series

SnapLatch Free Socket

1P Series



Features

- Locking system: Push-Pull
- Multipole 2 to 14 contacts
- Solder cup, print contacts
- Touch & scoop proof
- Multiple key options to avoid cross mating
- Cable diameter: Ø2.7mm to 6.5mm
- Color coded nut: Black, White, Red, Yellow, Green, Blue, Grey

Technical Data

Material

- Outer shell and back nut : PSU/PEI UL 94V-0
- Insulator : polyetheretherketone UL 94V-0(Peek)
- Contact : Copper alloy plating Au

Environmental

- IP50 when mated
- Working temp.: PSU : -50°C~+150°C
PEI : -50°C~+170°C

Mechanical

- Mating cycle: > 2000 cycles

C1 Type

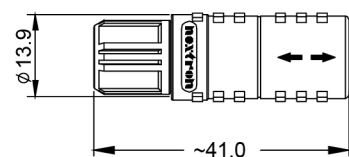

C3 Type

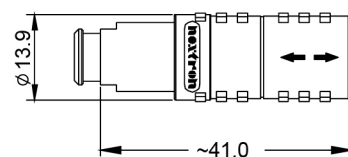

Unit : Millimeters. Dimensions for reference only.

Part Number & Spec. Description

R M * * * * P * 2 * * * * 0

STYLE

C1= Free Socket, female solder contact , standard back nut.
C3= Free Socket, female solder contact , bend relief back nut.

OUTER SHELL MATERIAL

G=Grey PSU F=Black PEI
B=Black PSU P=Grey PEI

BACK NUT COLOR

0= Black 2= RED 5= Green 8= Grey
1= White 4= Yellow 6= Blue

CONTACT DIAMETER

1=1.3mm (only for 2, 3 contacts) 3=0.7mm (only for 6, 7, 8 contacts)
2=0.9mm (only for 4, 5 contacts) 4=0.5mm (only for 9, 10, 12, 14 contacts)

NUMBER OF CONTACTS

02=2 contacts 06=6 contacts 10=10 contacts
03=3 contacts 07=7 contacts 14=14 contacts
04=4 contacts 08=8 contacts
05=5 contacts 09=9 contacts

ALIGNMENT KEY

0=0°
~*
J=205°

CABLE COLLET

1=Ø3.9mm (CableØ=2.7~3.9mm)
2=Ø5.2mm (CableØ=4.0~5.2mm)
3=Ø6.5mm (CableØ=5.3~6.5mm)

Note 1. Back nut material is same as outer shell.

Note 2. Insert configuration & operating voltage, please see page 53. **A**
Alignment key, please see page 54. **B**

Note 3. Cable O.D, please see page 56. **E**

Plastic 1P Series

SnapLatch Fixed Socket

1P Series



Features

- Locking system: Push-Pull
- Multipole 2 to 14 contacts
- Solder cup, print contacts
- Touch & scoop proof
- Multiple key options to avoid cross mating
- Color coded nut: Black, White, Red, Yellow, Green, Blue, Grey

Technical Data

Material

- Outer shell and front nut : PSU/PEI UL 94V-0
- Insulator : polyetheretherketone UL 94V-0(Peek)
- Contact : Copper alloy plating Au

Environmental

- IP50 when mated
- Working temp.: PSU : -50°C~+150°C
PEI : -50°C~+170°C

Mechanical

- Mating cycle: > 2000 cycles

B1 Type

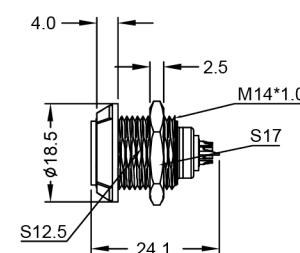

B3 Type

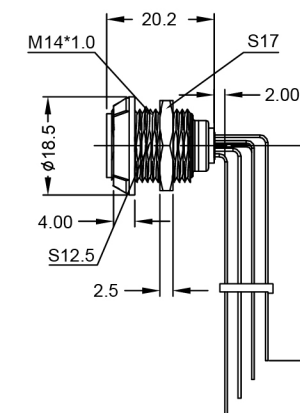

B4 Type

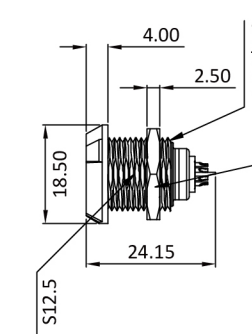

Unit : Millimeters. Dimensions for reference only.

Part Number & Spec. Description

R M * * * * P * 2 0 * * * * 0

STYLE

B1= Fixed socket, female solder contact, two nuts
B3= Fixed socket, female solder contact, 90° contacts for Printed circuit
B4= Fixed socket, female solder contact, nut fixing

OUTER SHELL MATERIAL

G=Grey PSU F=Black PEI
B=Black PSU P=Grey PEI

FRONT NUT COLOR

0= Black 2= RED 5= Green 8= Grey
1= White 4= Yellow 6= Blue

CONTACT DIAMETER

1=1.3mm(only for 2, 3 contacts) 3=0.7mm(only for 6, 7, 8 contacts)
2=0.9mm(only for 4, 5 contacts) 4=0.5mm(only for 9, 10, 12, 14 contacts)

NUMBER OF CONTACTS

02=2 contacts 08=8 contacts
03=3 contacts 09=9 contacts
04=4 contacts 10=10 contacts
05=5 contacts 12=12 contacts
06=6 contacts 14=14 contacts
07=7 contacts

ALIGNMENT KEY

0=0°
~*
J=205°

Note 1. Front nut material is same as outer shell. When the material is PEI, the color are only grey and black.

Note 2. Insert configuration & operating voltage, please see page 53. **A**
Alignment key, please see page 54. **B**

Plastic 1P Series

Fluidic Contact Straight Plug & Fixed Socket



Features

- Locking system: Push-Pull
- Fluidic contact for use of air / gas
- Multiple key options to avoid cross mating.
- Cable diameter: Ø5.3mm to 6.5mm
- Color coded nut: Black, White, Red, Yellow, Green, Blue, Grey

Technical Data

Material

- Outer shell and front / back nut : PSU UL 94V-0
- Insulator : polyetheretherketone UL 94V-0(Peek)
- Contact : Copper alloy plating Au

Environmental

- IP50 when mated
- Working temp.: PSU : -20°C~+150°C

Mechanical

- Mating cycle : > 2000 cycles

Plastic 1P Series

Disposable Straight Plug



Features

- Locking system: Push-Pull
- Multipole 4 to 14 contacts
- Solder cup, print contacts
- Touch & scoop proof
- Multiple key options to avoid cross mating

Technical Data

Material

- Outer Shell : PSU UL 94V-0
- Insulator : polyetheretherketone UL 94V-0(Peek)
- Contact : Copper alloy plating Au

Environmental

- IP50 when mated
- Working temp.: PSU : -50°C~+150°C

Mechanical

- Mating cycle : > 2000 cycles

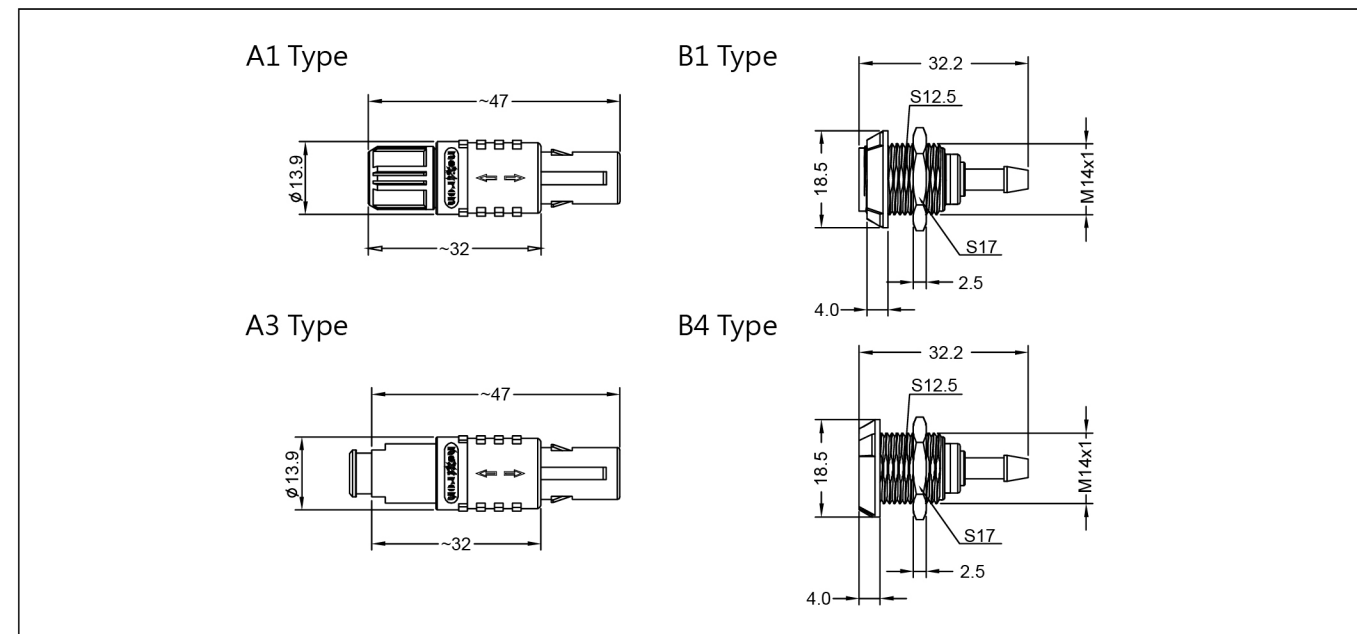

Unit : Millimeters. Dimensions for reference only.

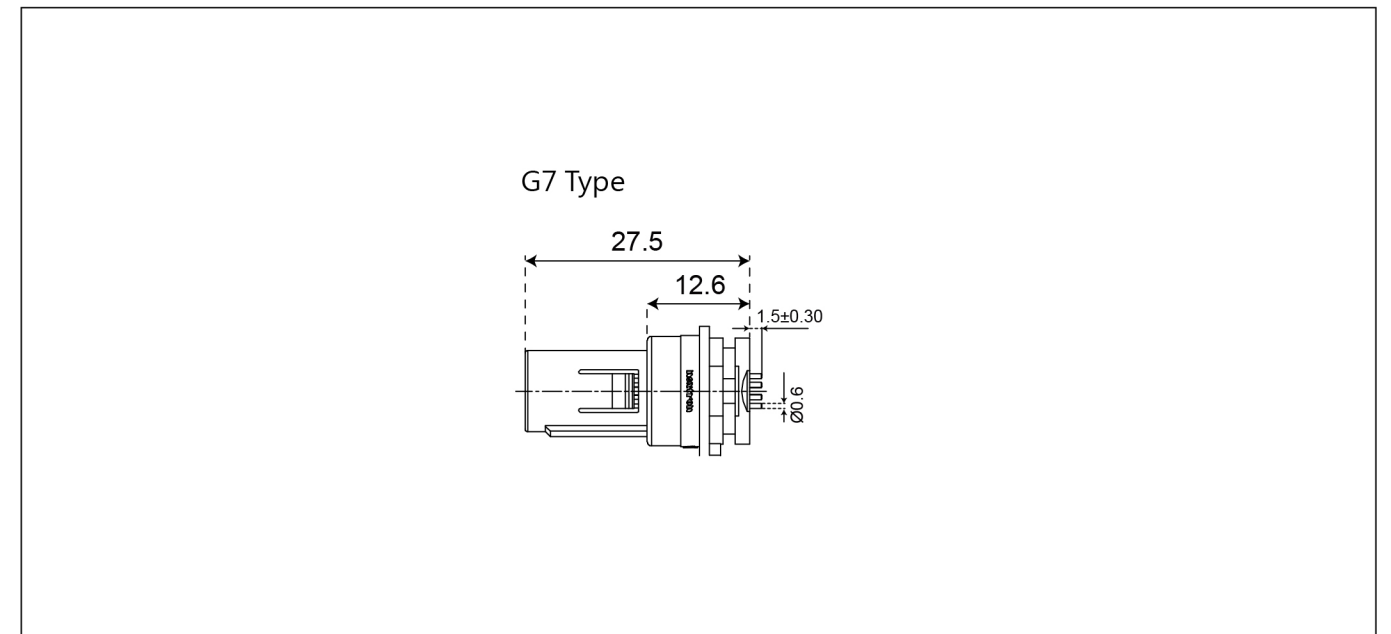

Unit : Millimeters. Dimensions for reference only.

Part Number & Spec. Description

Z M * * G * 0 0 0 * * 0 1 0

STYLE	A1= Straight Plug with cable collect and fluidic contact. A3= Straight Plug with cable collect and nut for fitting a bend relief with fluidic contact. B1= Fixed Socket with two nuts, back panel mounting with fluidic contact. B4= Fixed Socket, nut fixing with fluidic contact.
BACK & FRONT NUT COLOR	0= Black 2= RED 5= Green 8= Grey 1= White 4= Yellow 6= Blue
ALIGNMENT KEY	0=0° **~*** J=205°
CABLE COLLET	3=Ø 6.5mm (cable Ø=5.3~6.5mm) for A1 and A3 type 0=No cable collet for B1 and B4 type

Note 1. Front & back nut material is same as outer shell.
Note 2. Insert configuration & operating voltage, please see page 53. **A**
Alignment key, please see page 54. **B**
Note 3. Cable O.D, please see page 56. **E**

Part Number & Spec. Description

Z - M G 7 G N 0 L * 0 * * * 0

STYLE	G7= Disposable straight plug
OUT SHELL MATERIAL	G= Grey PSU
CONTACT TYPE	L= Male solder
NUMBER OF CONTACTS	02= 2 contacts 04= 4 contacts 05= 5 contacts 06= 6 contacts 10= 10 contacts 12= 12 contacts
ALIGNMENT KEY	0=0° A=40°
CONTACT PLATING	1= Gold plated 1u" 2= Gold plated 20u"

Note 1. Insert configuration & operating voltage, please see page 53. **A**
Alignment key, please see page 54. **B**

Plastic 1P Series

Disposable fixed socket

1P Series



Features

- Locking system: Push-Pull
- Multipole 4 to 14 contacts
- Solder cup, Print contacts
- Touch & scoop proof
- Multiple key options to avoid cross mating

Technical Data

- Material**
- Outer Shell: PSU UL 94V-0
 - Insulator : polyetheretherketone UL 94V-0(PEEK)
 - Contact : Copper alloy plating Au

- Environmental**
- IP50 when mated
 - Working temp.: PSU : -50 °C ~+150°C

- Mechanical**
- Mating cycle: > 2000 cycles

PY Type

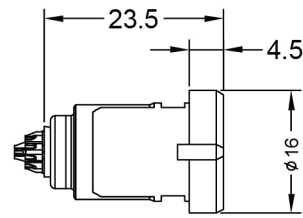

Unit : Millimeters. Dimensions for reference only.

Part Number & Spec. Description

Z - M P Y G N 0 L * 0 * * * 0

- STYLE**
PY= Disposable fixed socket, snap-on fixing
- OUTER SHELL MATERIAL**
G=Grey PSU
- CONTACT DIAMETER**
L=Female to solder
- CONTACT PLATING**
1= Gold plated 1u"
2= Gold plated 20u"

- NUMBER OF CONTACTS**
04=4 Pin
05=5 Pin
10=10 Pin
14=14 Pin
- ALIGNMENT KEY**
0=0°
A=40°

Note 1. Insert configuration & operating voltage, please see page 53. **A**
Alignment key, please see page 54. **B**

Plastic 1P Series

Watertight Straight Plug IP64

1P Series



Features

- Locking system: Push-Pull
- Multipole 2 to 14 contacts
- Solder cup contacts
- Touch & scoop proof
- Multiple key options to avoid cross mating
- Cable diameter: Ø2.7mm to 6.5mm

Technical Data

- Material**
- Outer shell and back nut : PSU/PEI UL 94V-0
 - Insulator : polyetheretherketone UL 94V-0(PEEK)
 - Contact : Copper alloy plating Au

- Environmental**
- IP64 when mated
 - Working temp.: PSU : -50 °C ~+90°C
PEI : -50 °C ~+90°C

- Mechanical**
- Mating cycle : > 2000 cycles

PF & PB Type

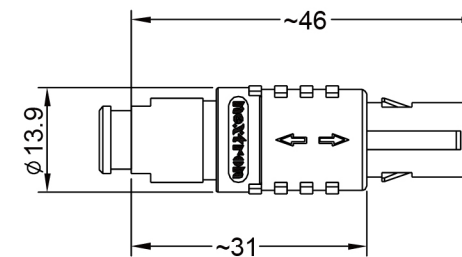

Unit : Millimeters. Dimensions for reference only.

Part Number & Spec. Description

R M * * * * P * 2 * * * * 0

- STYLE**
PF= Straight plug, male solder contact, bend relief back nut.(IP64)
PB= Straight plug, female solder contact, bend relief back nut.(IP64)
- OUTER SHELL MATERIAL**
G=Grey PSU F=Black PEI
B=Black PSU P=Grey PEI
- BACK NUT COLOR**
0= Black
8= Grey
- CONTACT DIAMETER**
1=1.3mm(only for 2, 3 contacts) 3=0.7mm(only for 6, 7, 8 contacts)
2=0.9mm(only for 4, 5 contacts) 4=0.5mm(only for 9, 10, 14 contacts)

- NUMBER OF CONTACTS**
02=2 contacts 07=7 contacts
03=3 contacts 08=8 contacts
04=4 contacts 09=9 contacts
05=5 contacts 10=10 contacts
06=6 contacts 14=14 contacts
- ALIGNMENT KEY**
0=0°
~
J=205°
- CABLE COLLET**
1=Ø 3.9mm (cable Ø=2.7~3.9mm)
2=Ø 5.2mm (cable Ø=4.0~5.2mm)
3=Ø 6.5mm (cable Ø=5.3~6.5mm)

Note 1. Back nut material is same as outer shell.
Note 2. Insert configuration & operating voltage, please see page 53. **A**
Alignment key, please see page 54. **B**
Note 3. Cable O.D, please see page 56. **E**

Plastic 1P Series

Watertight Straight Plug IP67

1P Series



Features

- Locking system: Push-Pull
- Multipole 2 to 14 contacts
- Solder cup contacts
- Touch & scoop proof
- Multiple key options to avoid cross mating
- Cable diameter: Ø2.7mm to 6.5mm

Technical Data

Material

- Outer shell and back nut: PSU/PEI UL94V-0
- Insulator: polyetheretherketone UL 94V-0(Peek)
- Contact: Copper alloy plating Au over nickel

Environmental

- IP67 when mated
- Working temp.: PSU : -50°C~+90°C
- PEI : -50°C~+90°C

Mechanical

- Mating cycle: > 2000 cycles

PK Type

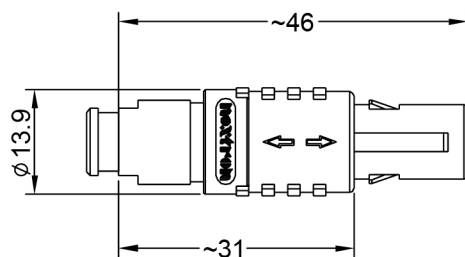

Unit : Millimeters. Dimensions for reference only.

Part Number & Spec. Description

R M P K * * P * 2 * * * * 0

STYLE
PK= Straight plug, male solder contact, bend relief back nut (IP67)

OUTER SHELL MATERIAL
G=Grey PSU F=Black PEI
B=Black PSU P=Grey PEI

BACK NUT COLOR
0= Black (same as the outer shell)
8= Grey (same as the outer shell)

CONTACT DIAMETER
1=1.3mm (only for 2, 3 contacts) 3=0.7mm (only for 6, 7, 8 contacts)
2=0.9mm (only for 4, 5 contacts) 4=0.5mm (only for 9, 10, 14 contacts)

NUMBER OF CONTACTS
02=2 contacts 07=7 contacts
03=3 contacts 08=8 contacts
04=4 contacts 09=9 contacts
05=5 contacts 10=10 contacts
06=6 contacts 14=14 contacts

ALIGNMENT KEY
0=0°
~*
J=205°

CABLE COLLET
1=Ø3.9mm (cable Ø=2.7~3.9mm)
2=Ø5.2mm (cable Ø=4.0~5.2mm)
3=Ø6.5mm (cable Ø=5.3~6.5mm)

Note 1. back nut material is same as outer shell.
Note 2. Insert configuration & operating voltage, please see page.53 **A**
Alignment key, please see page.54 **B**
Note 3. Cable O.D, please see page 56 **E**

Plastic 1P Series

Watertight Free Socket IP64

1P Series



Features

- Locking system: Push-Pull
- Multipole 2 to 14 contacts
- Solder cup contacts
- Touch & scoop proof
- Multiple key options to avoid cross mating
- Cable diameter: Ø2.7mm to 6.5mm

Technical Data

Material

- Outer shell and back nut : PSU/PEI UL 94V-0
- Insulator : polyetheretherketone UL 94V-0(Peek)
- Contact : Copper alloy plating Au

Environmental

- IP67 when mated
- Working temp.: PSU: -50°C~+90°C
- PEI : -50°C~+90°C

Mechanical

- Mating cycle: > 2000 cycles

PS & PC Type

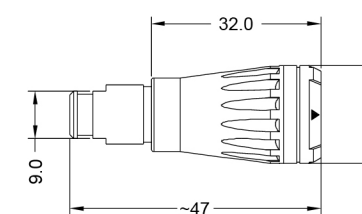

Unit : Millimeters. Dimensions for reference only.

Part Number & Spec. Description

R M P * * * P * 2 * * * * G

STYLE
PS=Free socket, female solder contact, bend relief back nut(IP64)
PC=Free socket, male solder contact, bend relief back nut(IP64)

OUTER SHELL MATERIAL
G=Grey PSU F=Black PEI
B=Black PSU P=Grey PEI

BACK NUT COLOR
0= Black (Same as outer shell)
8= Grey (Same as outer shell)

CONTACT DIAMETER
1=1.3mm (only for 2, 3 contacts) 3=0.7mm (only for 6, 7, 8 contacts)
2=0.9mm (only for 4, 5 contacts) 4=0.5mm (only for 9, 10, 14 contacts)

NUMBER OF CONTACTS
02=2 contacts 07=7 contacts
03=3 contacts 08=8 contacts
04=4 contacts 09=9 contacts
05=5 contacts 10=10 contacts
06=6 contacts 14=14 contacts

ALIGNMENT KEY
0=0°
~*
J=205°

CABLE COLLET
1=Ø3.9mm (cable Ø=2.7~3.9mm)
2=Ø5.2mm (cable Ø=4.0~5.2mm)
3=Ø6.5mm (cable Ø=5.3~6.5mm)

Note 1. Back nut material is same as outer shell.
Note 2. Insert configuration & operating voltage, please see page.53 **A**
Alignment key, please see page.54 **B**
Note 3. Cable O.D, please see page. 56 **E**

Plastic 1P Series

Watertight Fixed Socket IP64

1P Series



Features

- Locking system: Push-Pull
- Multipole 2 to 14 contacts
- Solder cup contacts
- Touch & scoop proof
- Multiple key options to avoid cross mating
- Cable diameter: Ø2.7mm to 6.5mm

Technical Data

Material

- Outer shell and front nut : PSU/PEI UL 94V-0
- Insulator : polyetheretherketone UL 94V-0(PEEK)
- Contact : Copper alloy plating Au

Environmental

- IP67 when mated
- Working temp.: PSU: -50°C~+90°C
PEI : -50°C~+90°C

Mechanical

- Mating cycle: > 2000 cycles

PN & PA Type

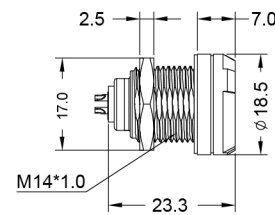

Unit : Millimeters. Dimensions for reference only.

Part Number & Spec. Description

R M P * * * P * 2 0 * * * G

STYLE

- PN=Fixed socket, female solder contact(IP64)
- PA=Fixed socket, male solder contact(IP64)

OUTER SHELL MATERIAL

- G=Grey PSU F=Black PEI
- B=Black PSU P=Grey PEI

FRONT NUT COLOR

- 0= Black(Same as outer shell)
- 8= Grey(Same as outer shell)

CONTACT DIAMETER

- 1=1.3mm(only for 2, 3 contacts) 3=0.7mm(only for 6, 7, 8 contacts)
- 2=0.9mm(only for 4, 5 contacts) 4=0.5mm(only for 9, 10, 14 contacts)

NUMBER OF CONTACTS

- 02=2 contacts 07=7 contacts
- 03=3 contacts 08=8 contacts
- 04=4 contacts 09=9 contacts
- 05=5 contacts 10=10 contacts
- 06=6 contacts 14=14 contacts

ALIGNMENT KEY

- 0=0°
- **~**
- J=205°

Note 1. Front nut material is same as outer shell.
Note 2. Insert configuration & operating voltage, please see page 53. **A**
Alignment key, please see page 54. **B**

Plastic 1P Series

Watertight Fixed Socket IP67

1P Series



Features

- Locking system: Push-Pull
- Multipole 2 to 14 contacts
- Solder cup contacts
- Touch & scoop proof
- Multiple key options to avoid cross mating.
- Cable diameter: Ø2.7mm to 6.5mm

Technical Data

Material

- Outer shell and front nut : PSU/PEI UL 94V-0
- Insulator : polyetheretherketone UL 94V-0(PEEK)
- Contact : Copper alloy plating Au

Environmental

- IP67 when mated
- Working temp.: PSU : -50 °C ~+90°C
PEI : -50 °C ~+90°C

Mechanical

- Mating cycle : >2000 cycles

PR Type

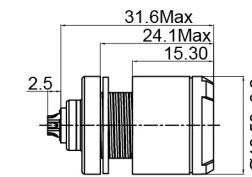

Unit : Millimeters. Dimensions for reference only.

Part Number & Spec. Description

R M P R * * P * 2 0 * * * G

STYLE

- PR=Fixed socket, female solder contact(IP64)

OUTER SHELL MATERIAL

- G=Grey PSU F=Black PEI
- B=Black PSU P=Grey PEI

FRONT NUT COLOR

- 0= Black(same as the outer shell)
- 8= Grey(same as the outer shell)

CONTACT DIAMETER

- 1=1.3mm(only for 2, 3 contacts) 3=0.7mm(only for 6, 7, 8 contacts)
- 2=0.9mm(only for 4, 5 contacts) 4=0.5mm(only for 9, 10, 14 contacts)

NUMBER OF CONTACTS

- 02=2 contacts 07=7 contacts
- 03=3 contacts 08=8 contacts
- 04=4 contacts 09=9 contacts
- 05=5 contacts 10=10 contacts
- 06=6 contacts 14=14 contacts

ALIGNMENT KEY

- 0=0°
- **~**
- J=205°

Note 1. Front nut material is same as outer shell.
Note 2. Insert configuration & operating voltage, please see page.53. **A**
Alignment key, please see page.54. **B**

Plastic 2P Series

SnapLatch Straight Plug



Features

- Locking system: Push-Pull
- Multipole 2 to 34 contacts
- Solder cup contacts
- Touch & scoop proof
- Multiple key options to avoid cross mating
- Cable diameter: \varnothing 3.2mm to 9.2mm
- Color coded nut: Black, White, Red, Yellow, Green, Blue, Grey

Technical Data

Material

- Outer shell and back nut : PSU/PEI UL 94V-0
- Insulator : polyetheretherketone UL 94V-0(Peek)
- Contact : Copper alloy plating Au

Environmental

- IP50 when mated
- Working temp.: PSU : -50°C~+150°C
PEI : -50°C~+170°C

Mechanical

- Mating cycle : >1000 cycles

Plastic 2P Series

SnapLatch Free Socket



Features

- Locking system: Push-Pull
- Multipole 2 to 34 contacts
- Solder cup contacts
- Touch & scoop proof
- Multiple key options to avoid cross mating
- Cable diameter: \varnothing 3.2mm to 9.2mm
- Color coded nut: Black, White, Red, Yellow, Green, Blue, Grey

Technical Data

Material

- Outer shell and back nut : PSU/PEI UL 94V-0
- Insulator : polyetheretherketone UL 94V-0(Peek)
- Contact : Copper alloy plating Au

Environmental

- IP50 when mated
- Working temp.: PSU : -50°C~+150°C
PEI : -50°C~+170°C

Mechanical

- Mating cycle : >1000 cycles

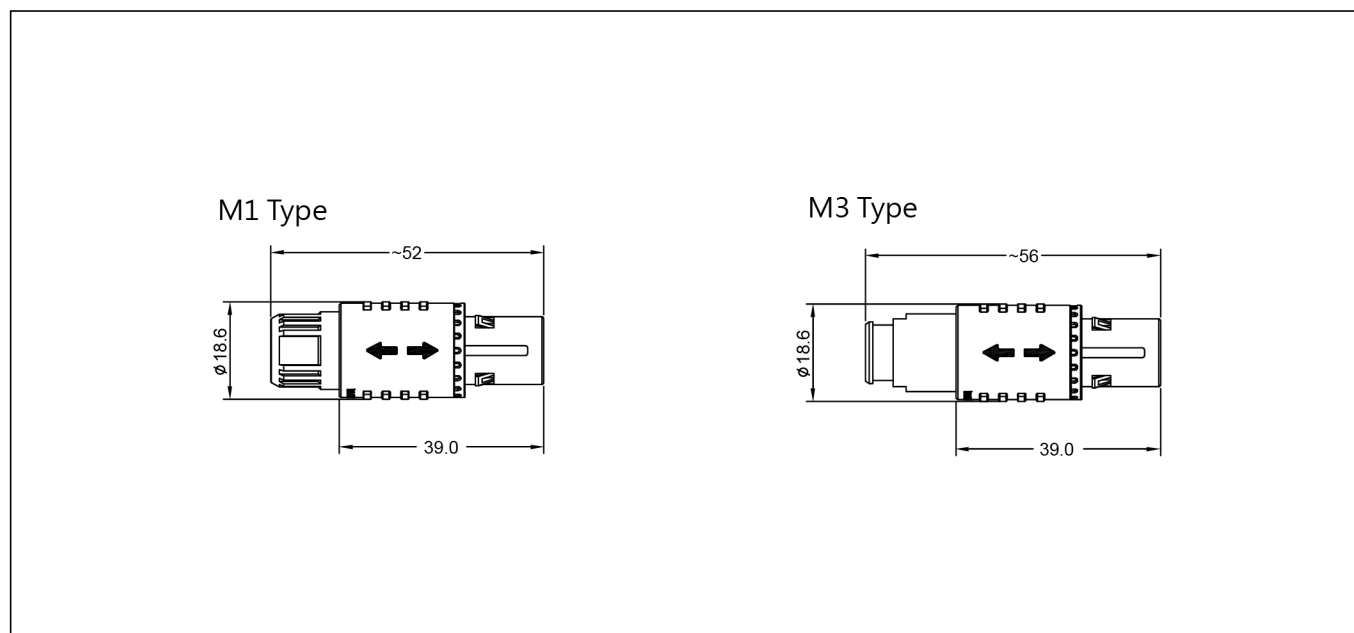

Unit : Millimeters. Dimensions for reference only.

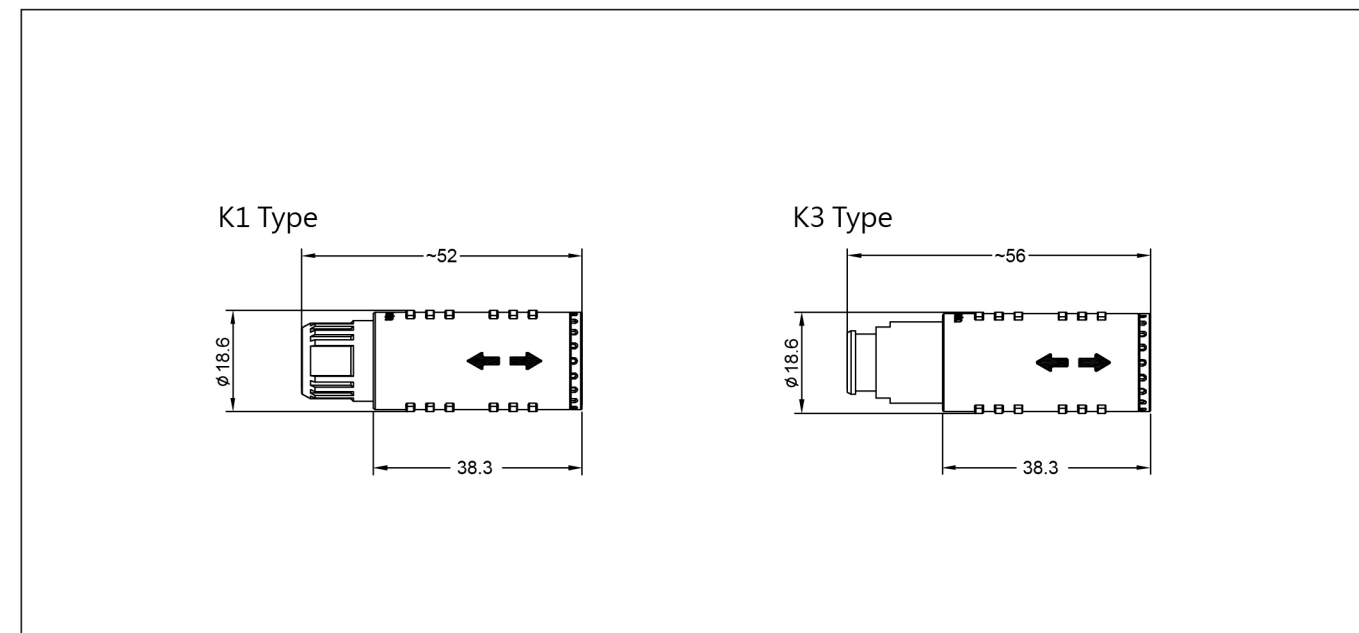

Unit : Millimeters. Dimensions for reference only.

Part Number & Spec. Description

R - M * * * * P * 2 * * * * 0

STYLE

- M1= Straight plug with standard back nut.
- M3= Straight plug with bend relief back nut.

OUTER SHELL MATERIAL

- G= Grey PSU F= Black PEI
- B= Black PSU P= Grey PEI

BACK NUT COLOR

- 0= Black 2= RED 5= Green 8= Grey
- 1= White 4= Yellow 6= Blue

CONTACT TYPE

- A= Male solder contact.
- L= Female solder contact.

NUMBER OF CONTACTS

- 02=02 contacts 10=10 contacts
- 03=03 contacts 12=12 contacts
- 04=04 contacts 16=16 contacts
- 05=05 contacts 19=19 contacts
- 06=06 contacts 26=26 contacts
- 07=07 contacts 32=32 contacts
- 08=08 contacts 34=34 contacts

ALIGNMENT KEY

- B=60°
- ***=
- S=130°

CABLE COLLET

- 1= \varnothing 5.2mm (CABLE \varnothing =3.2~5.2mm)
- 2= \varnothing 7.2mm (CABLE \varnothing =5.3~7.2mm)
- 3= \varnothing 9.2mm (CABLE \varnothing =7.3~9.2mm)

Note 1. Back nut material is same as outer shell.
The color of the back unit for M3 type are grey and black only.
Note 2. Insert configuration, alignment key & operating voltage, please see page 55. **A & B**
Note 3. Cable O.D, please see page 56. **E**

Part Number & Spec. Description

R - M * * * * P * 2 * * * * G

STYLE

- K1= Free socket with standard back nut
- K3= Free socket with with bend relief back nut

OUTER SHELL MATERIAL

- G= Grey PSU F= Black PEI
- B= Black PSU P= Grey PEI

BACK NUT COLOR

- 0= Black 2= RED 5= Green 8= Grey
- 1= White 4= Yellow 6= Blue

CONTACT TYPE

- A= Male solder contact.
- L= Female solder contact

NUMBER OF CONTACTS

- 03=3 contacts 19=19 contacts
- 08=8 contacts 26=26 contacts
- 10=10 contacts 32=32 contacts
- 12=12 contacts 34=34 contacts
- 16=16 contacts

ALIGNMENT KEY

- B=60°
- ***=
- S=130°

CABLE COLLET

- 1= \varnothing 5.2mm (Cable \varnothing =3.2~5.2mm)
- 2= \varnothing 7.2mm (Cable \varnothing =5.3~7.2mm)
- 3= \varnothing 9.2mm (Cable \varnothing =7.3~9.2mm)

Note 1. Back nut material is same as outer shell.
The color of the back unit for M3 type are grey and black only.
Note 2. Insert configuration, alignment key & operating voltage, please see page 55. **A & B**
Note 3. Cable O.D, please see page 56. **E**

Plastic 2P Series

SnapLatch Fixed Socket



Features

- Locking system: Push-Pull
- Multipole 2 to 34 contacts
- Solder cup contacts
- Touch & scoop proof
- Multiple key options to avoid cross mating
- Color coded nut: Black, White, Red, Yellow, Green, Blue, Grey

Technical Data

Material

- Outer shell and front nut : PSU/PEI UL 94V-0
- Insulator : polyetheretherketone UL 94V-0(Peek)
- Contact : Copper alloy plating Au

Environmental

- IP50 when mated
- Working temp.: PSU : -50°C~+150°C
- PEI : -50°C~+170°C

Mechanical

- Mating cycle : >1000 cycles

Plastic 2P Series

Disposable Straight Plug IP64



Features

- Locking system: Push-Pull
- Multipole 16 contacts
- Solder cup contacts
- Touch & scoop proof
- Multiple key options to avoid cross mating

Technical Data

Material

- Outer Shell : PSU/PEI UL 94V-0
- Insulator : polyetheretherketone UL 94V-0(Peek)
- Contact : Copper alloy plating Au

Environmental

- IP64 when mated
- Working temp.: PSU : -50°C~+150°C
- PEI : -50°C~+170°C

Mechanical

- Mating cycle : >1000 cycles

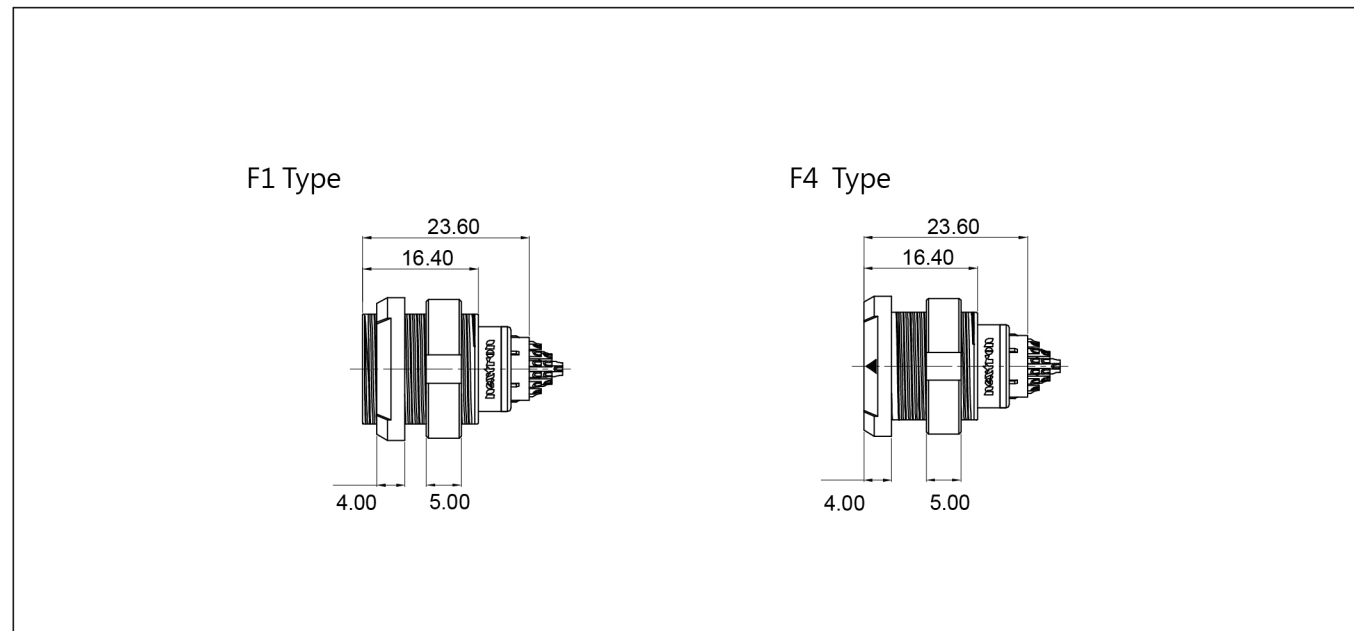

Unit : Millimeters. Dimensions for reference only.

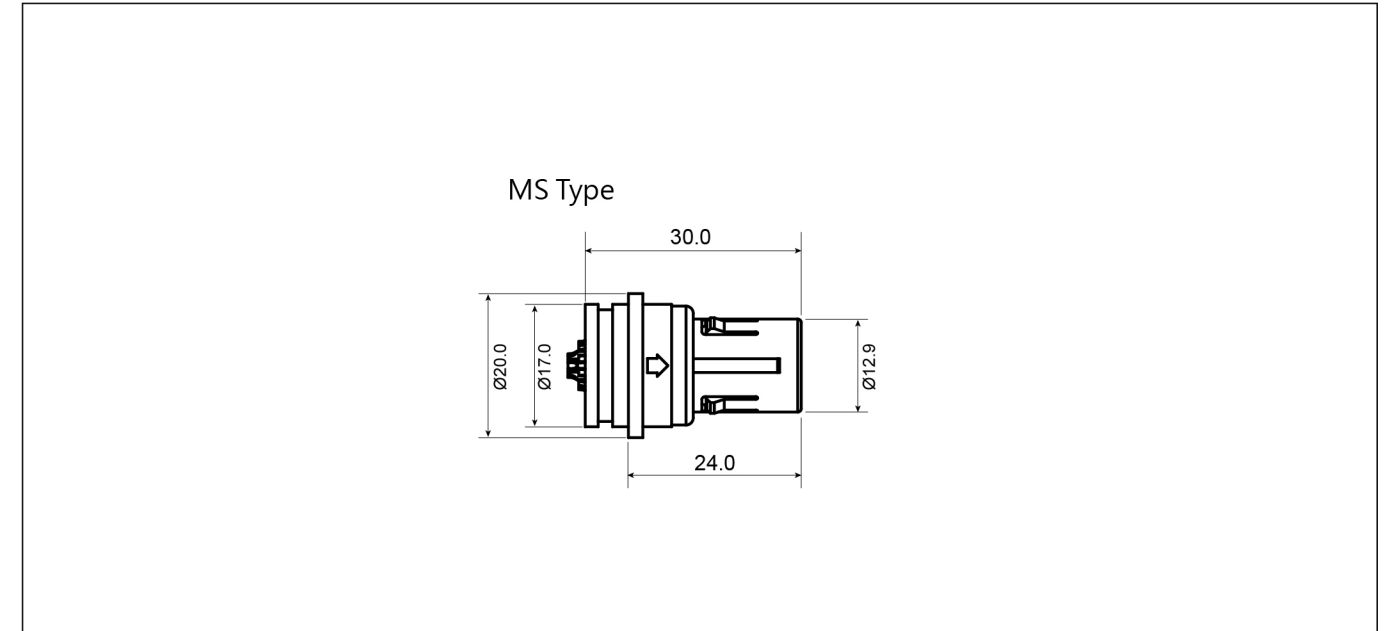

Unit : Millimeters. Dimensions for reference only.

Part Number & Spec. Description

R - M * * * * P L 2 0 * * * 0

STYLE

- F1=Fixed socket with two nuts, back panel mounting
- F4=Fixed socket, plastic front nut fixing

OUTER SHELL MATERIAL

- G=Grey PSU F=Black PEI
- B=Black PSU P=Grey PEI

FRONT NUT COLOR

- 0= Black 2= RED 5= Green 8= Grey
- 1= White 4= Yellow 6= Blue

NUMBER OF CONTACTS

- 02=2 contacts 10=10 contacts
- 03=3 contacts 12=12 contacts
- 04=4 contacts 16=16 contacts
- 05=5 contacts 19=19 contacts
- 06=6 contacts 26=26 contacts
- 07=7 contacts 32=32 contacts
- 08=8 contacts 34=34 contacts

ALIGNMENT KEY

- B=60°
- ***=**
- S=130°

Note 1. Back nut material is same as outer shell.
Note 2. Insert configuration, alignment key & operating voltage, please see page 55. **A** & **B**

Part Number & Spec. Description

R - M M S * 0 0 * 2 0 * 1 6 0

STYLE

- MS=Disposable straight plug IP64

OUTER SHELL MATERIAL

- G=Grey PSU F=Black PEI
- B=Black PSU P=Grey PEI

CONTACT TYPE

- L=Female solder contact
- A=Male solder contact

NUMBER OF CONTACTS

- 16=16 contacts

ALIGNMENT KEY

- B=60° H=80° J=90° C=100°

CONTACT PLATING

- 1=Gold plated 1u"
- 2=Gold plated 20u"

Note 1. Insert configuration, alignment key & operating voltage, please see page 55. **A** & **B**

Plastic 2P Series

SnapLatch Fixed Socket IP64



Features

- Locking system: Push-Pull
- Multipole 2 to 34 contacts
- Solder cup contacts
- Touch & scoop proof
- Multiple key options to avoid cross mating
- Cable diameter: Ø3.2mm to 9.2mm
- Color-coded nut: Black, White, Red, Yellow, Green, Blue, Grey

Technical Data

Material

- Outer shell and front nut : PSU/PEI UL 94V-0
- Insulator : polyetheretherketone UL 94V-0(Peek)
- Contact : Copper alloy plating Au

Environmental

- IP64 when mated
- Working temp.: PSU : -50°C~+150°C
- PEI : -50°C~+170°C

Mechanical

- Mating cycle : >1000 cycles

Plastic 2P Series

Coaxial Medical Straight Plug



Features

- Locking system: Push-Pull
- Multipole 4 contacts
- Coaxial contact with low voltage
- Coaxial contact impedance 500Ω
- Solder cup contacts
- Touch & scoop proof
- Multiple key options to avoid cross mating
- Cable diameter: Ø3.2mm to 9.2mm
- Color-coded nut: Black, White, Red, Yellow, Green, Blue, Grey

Technical Data

Material

- Outer shell and back nut : PSU/PEI UL 94V-0
- Insulator : polyetheretherketone UL 94V-0(Peek)
- Contact : Copper alloy plating Au

Environmental

- IP64 when mated
- Working temp.: PSU : -50°C~+150°C
- PEI : -50°C~+170°C

Mechanical

- Mating cycle : >500 cycles

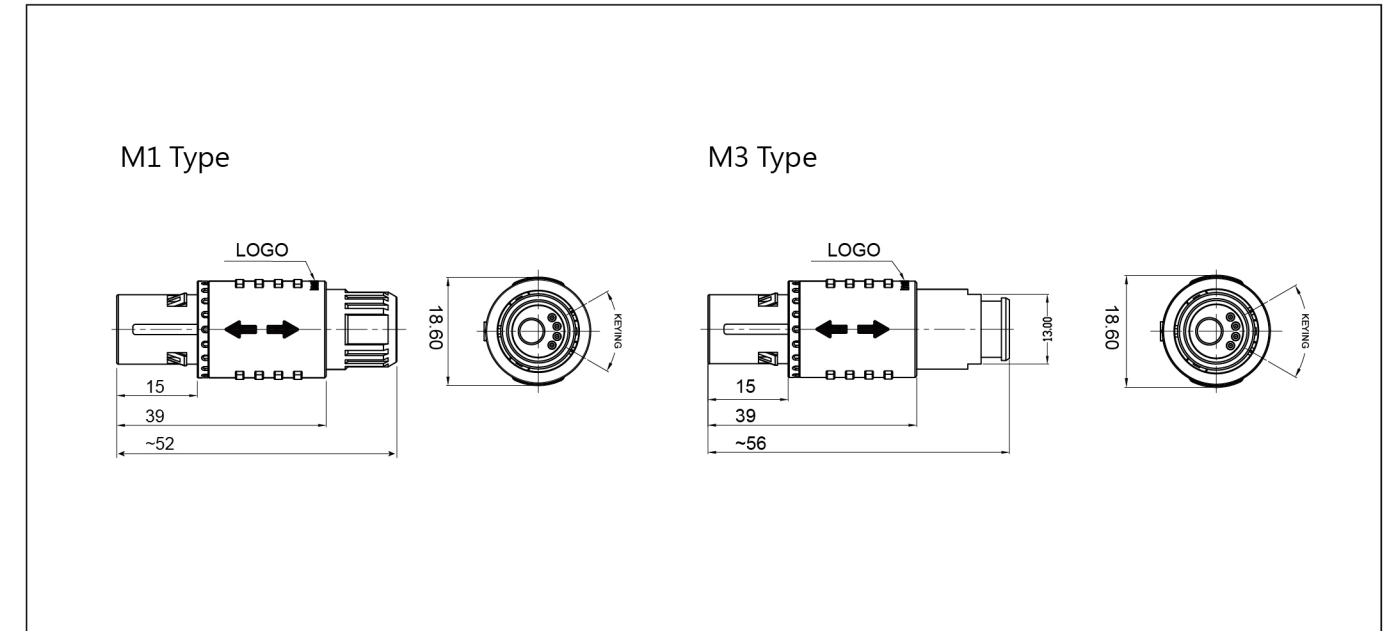
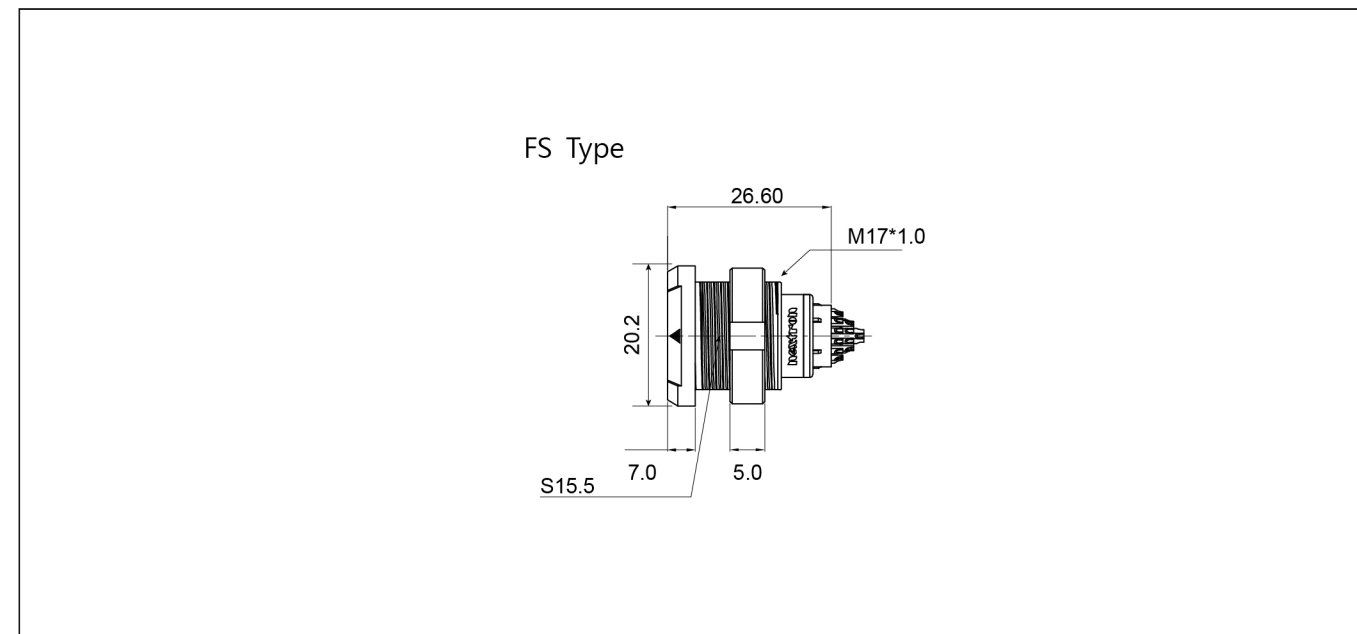

Unit : Millimeters. Dimensions for reference only.

Unit : Millimeters. Dimensions for reference only.

Part Number & Spec. Description

R - M F S * * P L 2 0 * 1 6 0

OUTER SHELL MATERIAL

FS=Fixed socket with two nits and two gasket IP64

OUTER SHELL MATERIAL

G=Grey PSU F=Black PEI
B=Black PSU P=Grey PEI

FRONT NUT COLOR

0= Black 2= RED 5= Green 8= Grey
1= White 4= Yellow 6= Blue

CONTACT TYPE

L=Female solder contact

Note 1. Front nut material is same as outer shell.
Note 2. Insert configuration, alignment key & operating voltage, please see page.55 **A** & **B**

NUMBER OF CONTACTS 16=16 contacts

ALIGNMENT KEY B=60°
~
S=130°

Part Number & Spec. Description

R - M * * * * P * 2 * * 8 4 0

STYLE

M1=Straight plug with standard back nut.
M3=Straight plug with bend relief back nut.

OUTER SHELL MATERIAL

G=Grey PSU F=Black PEI
B=Black PSU P=Grey PEI

BACK NUT COLOR

0= Black 2= RED 5= Green 8= Grey
1= White 4= Yellow 6= Blue

CONTACT TYPE

A=Male solder contact.
L=Female solder contact

Note 1. Back nut material is same as outer shell.
Note 2. Insert configuration, alignment key & operating voltage, please see page.55 **A** & **B**
Note 3. Cable O.D, please see page. 56 **E**

NUMBER OF CONTACTS 04=4 contacts

ALIGNMENT KEY B=60°
~
S=130°

CABLE COLLET 1=Ø5.2mm(cable Ø=3.2~5.2mm)
2=Ø7.2mm(cable Ø=5.3~7.2mm)
3=Ø9.2mm(cable Ø=7.3~9.2mm)

Plastic 2P Series

Coaxial Medical Fixed Socket

2P Series



Features

- Locking system: Push-Pull
- Multipole 4 contacts
- Coaxial contact with low voltage
- Coaxial contact impedance 500Ω
- Solder cup contacts
- Touch & scoop proof
- Multiple key options to avoid cross mating
- Color coded nut: Black, White, Red, Yellow, Green, Blue, Grey

Technical Data

Material

- Outer shell and front nut : PSU/PEI UL 94V-0
- Insulator : polyetheretherketone UL 94V-0(PEEK)
- Contact : Copper alloy plating Au

Environmental

- IP64 when mated
- Working temp.: PSU : -50°C~+150°C
PEI : -50°C~+170°C

Mechanical

- Mating cycle : > 500 cycles

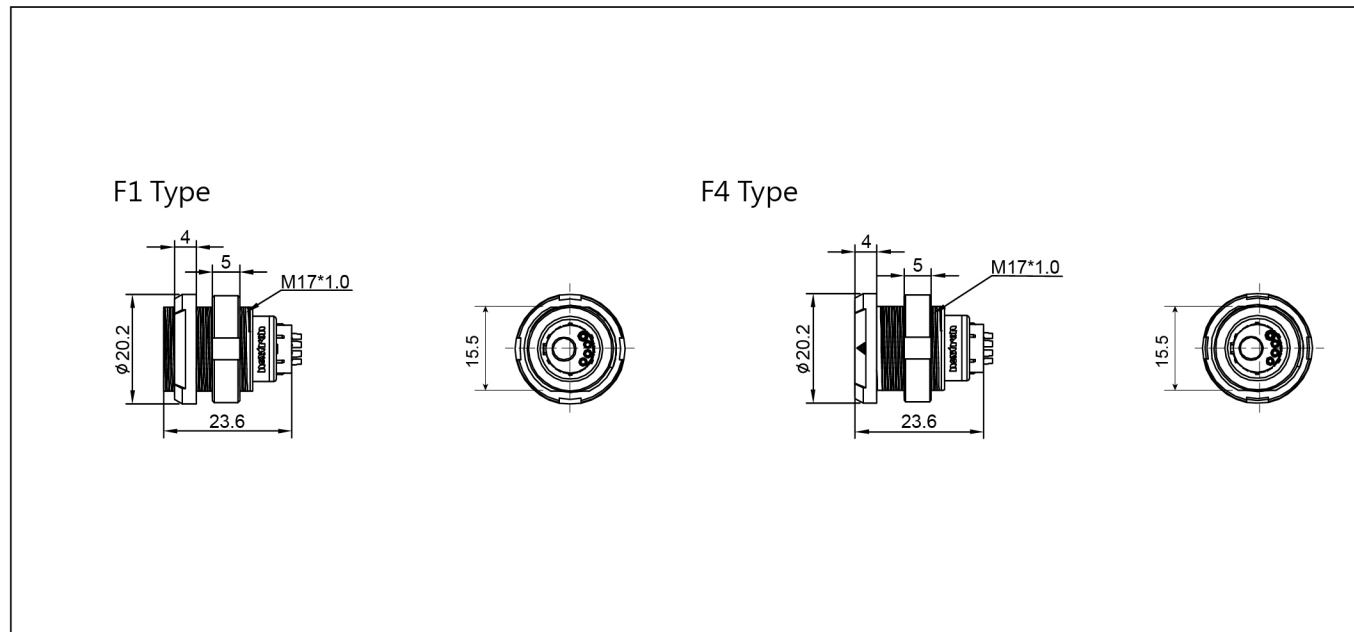

Unit : Millimeters. Dimensions for reference only.

Part Number & Spec. Description

R - M * * * * P * 2 0 * 8 4 0

STYLE

- F1=Fixed socket with two nuts, back panel mounting
- F4= Fixed socket, plastic front nut fixing

OUTER SHELL MATERIAL

- G=Grey PSU F=Black PEI
- B=Black PSU P=Grey PEI

FRONT NUT COLOR

- 0= Black 2= RED 5= Green 8= Grey
- 1= White 4= Yellow 6= Blue

CONTACT TYPE

- L=Female solder contact
- A=Male solder contact

NUMBER OF CONTACTS

04=4 contacts

ALIGNMENT KEY

B=60°
~~*~
S=130°

Note 1. Front nut material is same as outer shell.
Note 2. Insert configuration, alignment key & operating voltage, please see page 55. **A** & **B**

Metal B Series

SnapLatch Straight Plug

B Series



Features

- Size 00, 0B, 1B, 2B
- Locking system: Push-Pull
- Multipole 2 to 32 contacts
- Solder cup, crimp contact
- Touch & scoop proof
- Multiple key options to avoid cross mating
- Cable diameter: Ø0.8mm to 9.9mm

Technical Data

Material

- Outer shell and back nut : Copper alloy plating Cr
- Insulator : polyetheretherketone UL 94V-0(PEEK)
- Contact : Copper alloy plating Au
- Other metallic components: Brass plating Ni

Environmental

- IP50 when mated
- Working temp. : -55°C~+250°C

Mechanical

- Mating cycle : > 5000 cycles

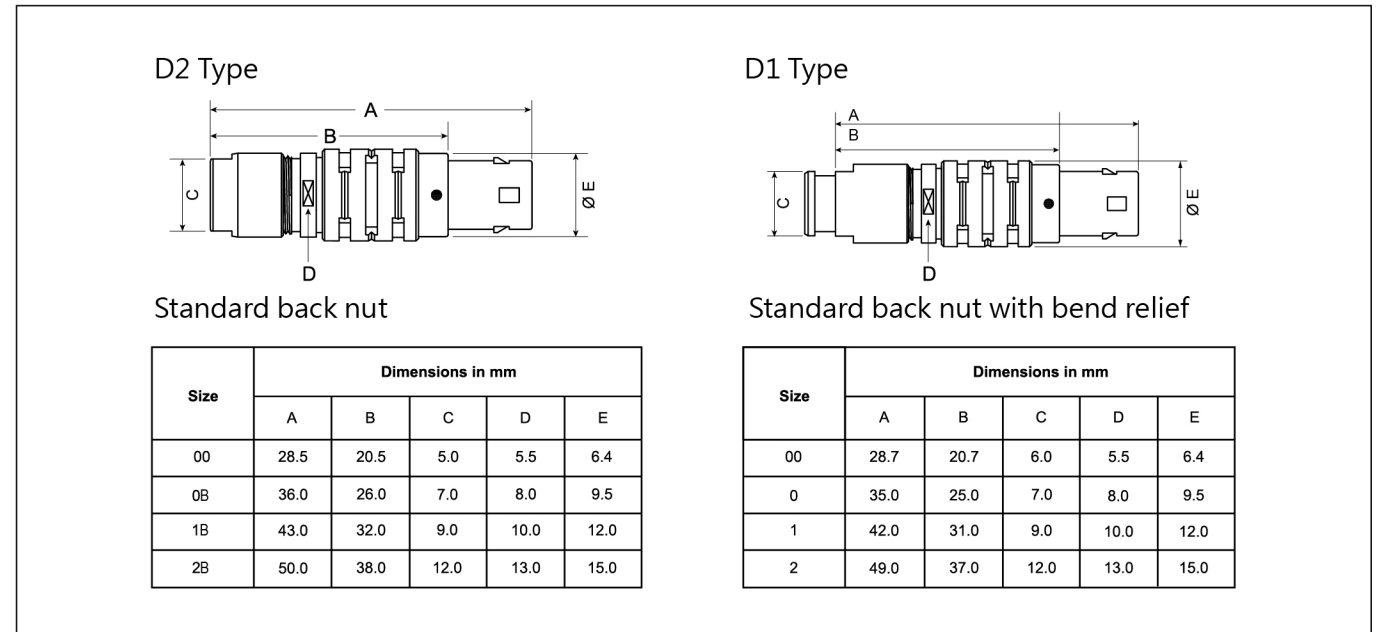

D2 Type

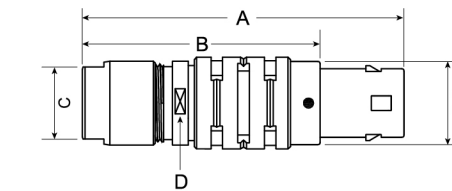

Standard back nut

Size	Dimensions in mm				
	A	B	C	D	E
00	28.5	20.5	5.0	5.5	6.4
0B	36.0	26.0	7.0	8.0	9.5
1B	43.0	32.0	9.0	10.0	12.0
2B	50.0	38.0	12.0	13.0	15.0

D1 Type

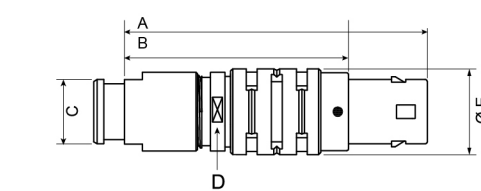

Standard back nut with bend relief

Size	Dimensions in mm				
	A	B	C	D	E
00	28.7	20.7	6.0	5.5	6.4
0	35.0	25.0	7.0	8.0	9.5
1	42.0	31.0	9.0	10.0	12.0
2	49.0	37.0	12.0	13.0	15.0

Unit : Millimeters. Dimensions for reference only.

Part Number & Spec. Description

R - F * * S * * 0 * D * * * *

SIZE

- 00=00 Size(2~4 contacts) 1B=1B Size(2~16 contacts)
- 0B=0B Size(2~9 contacts) 2B=2B Size(2~32 contacts)

NUMBER OF CONTACTS

- 02=2 contacts
- *~*~*~
- 32=32 contacts

CONTACTS TYPE

- 1=Male print contact 2=Male solder contact C=Male crimp contact
- 3=Female print contact 4=Female solder contact M=Female crimp contact

Note 1. Back nut material is same as outer shell.
Note 2. Insert configuration & operating voltage, please see page 57. **A**
Alignment key, please see page 58. **B**
Note 3. Cable O.D, please see page 60. **E**

CABLE O.D.

- 10= Ø 0.8mm ~ 1.3mm
- 22= Ø 1.4mm ~ 2.2mm
- 31= Ø 2.2mm ~ 3.2mm
- 52= Ø 4.2mm ~ 5.2mm
- *~*~*~
- 99= Ø 9.2mm ~ 9.9mm

ALIGNMENT KEY

- 0= 0°
- *~*~*~
- X=155°

BACK NUT

- 1= Nut with bend relief
- 2= Standard Nut

Metal B Series

SnapLatch Straight Plug with Lanyard Release



Features

- Size 0B, 1B
- Locking system: Push-Pull
- Multipole 2 to 16 contacts
- Solder cup, crimp contacts
- Touch & scoop proof
- Multiple key options to avoid cross mating
- Cable diameter: ϕ 1.4mm to 7.6mm

Technical Data

Material

- Outer Shell & back nut : Copper alloy plating Cr
- Insulator : polyetheretherketone UL 94V-0(Peek)
- Contact : Copper alloy plating Au
- Other metallic components: Copper alloy plating Ni

Environmental

- IP50 when mated
- Working temp. : -55°C~+250°C

Mechanical

- Mating cycle : > 5000 cycles

Metal B Series

SnapLatch Elbow Straight Plug



Features

- Size 1B, 2B
- Locking system: Push-Pull
- Multipole 2 to 32 contacts
- Solder cup, crimp contacts
- Touch & scoop proof
- Multiple key options to avoid cross mating
- Cable diameter: ϕ 3.1mm to 9.9mm

Technical Data

Material

- Outer Shell & back nut: Copper alloy plating Cr
- Insulator: polyetheretherketone UL 94V-0(Peek)
- Contact: Copper alloy plating Au
- Other metallic components: Copper alloy plating Ni

Environmental

- IP50 when mated
- Working temp. : -55°C~+250°C

Mechanical

- Mating cycle : > 5000 cycles

B Series

B Series

D2 Type

Standard back nut

Size	Dimensions in mm						
	A	B	C	D	N	S1	S2
0	9.5	15.5	36.0	26.0	140.0	8.0	7.0
1	12.0	18.0	43.0	32.0	140.0	10.0	9.0

D1 Type

Standard back nut with bend relief

Size	Dimensions in mm						
	A	B	C	D	N	S1	S2
0	9.5	15.5	37.0	27.0	140.0	8.0	7.0
1	12.0	18.0	44.0	33.0	140.0	10.0	9.0

Unit : Millimeters. Dimensions for reference only.

D2 Type

Standard back nut

Size	Dimensions in mm							
	A	B	C	D	E	S1	S2	S3
1	13.5	25.0	36.0	30.5	8.0	11.0	9.0	10.0
2	16.5	29.5	41.5	34.0	9.0	14.0	12.0	13.0

D1 Type

Standard back nut with bend relief

Size	Dimensions in mm							
	A	B	C	D	E	S1	S2	S3
1	13.5	25.0	36.0	30.5	8.0	11.0	9.0	11.0
2	16.5	29.5	41.5	35.0	9.0	14.0	12.0	13.0

Unit : Millimeters. Dimensions for reference only.

Part Number & Spec. Description

R - F * * C * * 0 * D * * * *

SIZE
 0B=0B Size(2~9 contacts)
 1B=1B Size(2~16 contacts)

NUMBER OF CONTACTS
 02=2 contacts
 ~~*
 16=16 contacts

CONTACTS TYPE
 2= Male solder contact C= Male crimp contact
 4= Female solder contact M= Female crimp contact

CABLE O.D.
 21= ϕ 1.4mm~2.2mm
 31= ϕ 2.2mm~3.2mm
 52= ϕ 4.2mm~5.2mm
 ~~*
 76= ϕ 7.2mm~7.6mm

ALIGNMENT KEY
 0= 0°
 ~~*
 X= 155°

BACK NUT
 1= Nut with bend relief
 2= Standard nut

Note 1. Back nut material is same as outer shell.
 Note 2. Insert configuration & operating voltage, please see page 57. **A**
 Alignment key, please see page 58. **B**
 Note 3. Cable O.D, please see page 60. **E**

Part Number & Spec. Description

R - F * * H * * 0 * D * * * *

SIZE
 1B=1B Size(2~16 contacts)
 2B=2B Size(2~32 contacts)

NUMBER OF CONTACTS
 02=02 contacts
 ~~*
 32=32 contacts

CONTACTS TYPE
 2= Male solder contact C= Male crimp contact
 4= Female solder contact M= Female crimp contact

CABLE O.D.
 42= ϕ 3.1mm~4.0mm
 52= ϕ 4.2mm~5.2mm
 ~~*
 99= ϕ 9.2mm~9.9mm

Alignment Key
 0= 0°
 ~~*
 X= 155°

BACK NUT
 1= Nut with bend relief
 2= Standard nut

Note 1. Back nut material is same as outer shell.
 Note 2. Insert configuration & operating voltage, please see page. 57. **A**
 Alignment key, please see page. 58. **B**
 Note 3. Cable O.D, please see page 60. **E**

Metal B Series

SnapLatch Free Socket



Features

- Size 00, 0B, 1B, 2B
- Locking system: Push-Pull
- Multipole 2 to 32 contacts
- Solder cup, crimp contacts
- Touch & scoop proof
- Multiple key options to avoid cross mating
- Cable diameter: \varnothing 0.8mm to 9.9mm

Technical Data

Material

- Outer Shell & back nut : Copper alloy plating Cr
- Insulator : polyetheretherketone UL 94V-0(Peek)
- Contact : Copper alloy plating Au
- Other metallic components: Copper alloy plating Ni

Environmental

- IP50 when mated
- Working temp. : $-55^{\circ}\text{C}\sim+250^{\circ}\text{C}$

Mechanical

- Mating cycle : > 5000 cycles

Metal B Series

SnapLatch Fixed Socket



Features

- Size 00, 0B, 1B, 2B
- Locking system: Push-Pull
- Multipole 2 to 32 contacts
- Solder cup, crimp, print contacts
- Touch & scoop proof
- Multiple key options to avoid cross mating

Technical Data

Material

- Outer Shell : Copper alloy plating Cr
- Insulator : polyetheretherketone UL 94V-0(Peek)
- Contact : Copper alloy plating Au
- Other metallic components: Copper alloy plating Ni

Environmental

- IP50 when mated
- Working temp. : $-55^{\circ}\text{C}\sim+250^{\circ}\text{C}$

Mechanical

- Mating cycle : > 5000 cycles

D2 Type

Standard back nut

Size	Dimensions in mm				
	A	B	C	D	E
00	26.0	6.8	6.4	5.5	6.0
0	35.5	9.5	8.8	8.0	7.0
1	40.5	12.5	11.2	10.0	9.0
2	47.0	16.5	15.0	13.0	12.0

D1 Type

Standard back nut with bend relief

Size	Dimensions in mm				
	A	B	C	D	E
00	34.0	6.8	6.4	5.5	6.0
0	34.5	9.5	8.8	8.0	7.0
1	39.5	12.5	11.2	10.0	9.0
2	46.0	16.5	15.0	13.0	12.0

Unit : Millimeters. Dimensions for reference only.

R Type

Fixed socket, Nut fixing

Size	Dimensions in mm				
	A	B	C	D	E
00	13.7	10.2	10.0	9.0	M7x0.5P
0	20.7	12.4	12.0	11.0	M9x0.6P
1	23.0	15.8	14.0	14.0	M12x1.0P
2	26.7	19.2	20.0	17.0	M15x1.0P

N Type

Fixed socket with two nuts

Size	Dimensions in mm				
	A	B	C	D	E
00	15.5	10.2	8.0	9.0	M7x0.5P
0	20.7	12.4	10.0	11.0	M9x0.6P
1	23.0	15.8	14.0	14.0	M12x1.0P
2	26.7	19.2	18.0	17.0	M15x1.0P

E Type

Fixed socket, back panel mounting

Size	Dimensions in mm			
	A	B	C	D
00	15.5	9.5	10.0	M7x0.5P
0	20.7	12.5	12.0	M9x0.6P
1	23.0	16.0	16.0	M12x1.0P
2	26.7	20.0	20.0	M15x1.0P

Unit : Millimeters. Dimensions for reference only.

Part Number & Spec. Description

R - F * * F * * 0 * D * * * *

SIZE

00=00 Size(2~4 contacts) 1B=1B Size(2~16 contacts)
 0B=0B Size(2~9 contacts) 2B=2B Size(2~32 contacts)

STYLE

F=Free Socket

NUMBER OF CONTACTS

02=02 contacts
 ~~*

32=32 contacts

CONTACTS TYPE

2= Male solder contact C= Male crimp contact
 4= Female solder contact M= Female crimp contact

CABLE O.D.

22= \varnothing 1.4mm ~ 2.2mm
 27= \varnothing 2.2mm ~ 2.7mm
 52= \varnothing 4.2mm ~ 5.2mm
 ~~*

99= \varnothing 9.2mm ~ 9.9mm

ALIGNMENT KEY

0= 0°
 ~~*
 X= 155°

BACK NUT

1= Nut with bend relief
 2= Standard nut

Note 1. Back nut material is same as outer shell.
 Note 2. Insert configuration & operating voltage, please see page. 57. **A**
 Alignment key, please see page.58. **B**
 Note 3. Cable O.D, please see page 60. **E**

Part Number & Spec. Description

R - F * * * * * 0 * 0 0 * 0 0

SIZE

00=00 Size(2~4 contacts) 1B=1B Size(2~16 contacts)
 0B=0B Size(2~9 contacts) 2B=2B Size(2~32 contacts)

STYLE

R=Receptacle
 N=Receptacle with two nut
 E=Receptacle and back panel mounting

NUMBER OF CONTACTS

02=02 contacts
 ~~*

32=32 contacts

ALIGNMENT KEY

0= 0°
 ~~*
 X= 155°

CONTACTS TYPE

1= Male print contact 4= Female solder contact
 2= Male solder contact C= Male crimp contact
 3= Female Print Contact M= Female crimp contact

Note 1. Insert configuration & operating voltage, please see page. 57. **A**
 Alignment key, please see page.58. **B**

Metal B Series

Non-Latching, Fixed Plug, Nut Fixing



Features

- Size 0, 1
- Locking system: Push-Pull
- Multipole 2 to 16 contacts
- Solder cup, crimp & print contacts
- Touch & scoop proof
- Multiple key options to avoid cross mating

Technical Data

Material

- Outer shell : Copper alloy plating Cr
- Insulator : polyetheretherketone UL 94V-0(Peek)
- Contact : Copper alloy plating Au over Ni
- Other metallic components : Copper alloy plating Ni

Environmental

- IP50 when mated
- Working temp. : -55°C~+250°C

Mechanical

- Mating cycle : > 5000 cycles

A Type

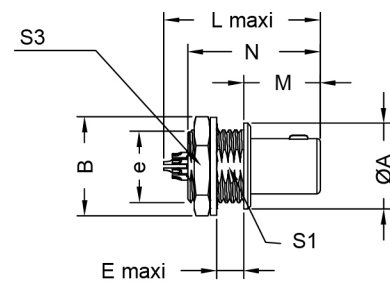

Size	Dimensions in mm									
	A	B	e	E	L	M	N ¹⁾	S1	S3	
0	10	12.4	M9x0.6	4.2	20.8	11.5	18.9	8.2	11	
1	14	15.8	M12x1.0	5.4	25.2	12.5	21.6	10.5	14	

Unit : Millimeters. Dimensions for reference only.

Part Number & Spec. Description

R - F * * A * * 0 * 0 0 * 0 0

SIZE

- 0B=0B Size(2~9 contacts)
- 1B=1B Size(2~16 contacts)

NUMBER OF CONTACTS

- 02=02 pin
- *****
- 16=16 pin

CONTACTS TYPE

- 2= Male solder contact
- 4= Female solder contact
- C= Male crimp contact
- M= Female crimp contact

ALIGNMENT KEY

- 0= 0°
- *2~*8*
- X= 155°

Note 1. Insert configuration & operating voltage, please see page 57. **A**
Alignment key, please see page 58. **B**

Metal T Series

SuapLatch Metal Straight Plug



Features

- Size TT, 0T, 1T, 2T
- Locking system: Push-Pull
- Multipole 2 to 32 contacts
- Solder cup contacts
- Touch & Scoop proof
- High density for space savings
- Multiple key options to avoid cross mating
- Cable diameter: Ø1.5mm to 10.5mm

Technical Data

Material

- Outer Shell & back nut: Copper alloy plating Cr
- Insulator : polyetheretherketone UL 94V-0(Peek)
- Contact : Copper alloy plating Ni

Environmental

- IP67 when mated
- Working temp.: -55°C~+200°C
- Humidity : Up to 95% at 60 °C
- Corrosion resistance: 144Hrs comply with IEC 60512-6

Mechanical

- Mating cycle: >3000 cycles
- Vibration: 10-2000Hz, 15g comply with IEC 60512-4
- Shock: 100g amplitude, half sine pulse of 6ms, no discontinuity>1us IEC 60512-4

D1 Type

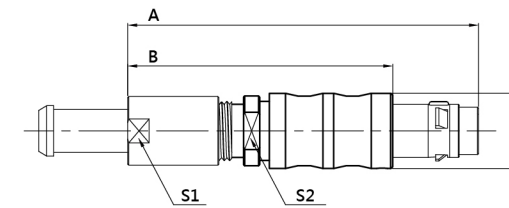

Standard back nut

Size	Dimensions in mm				
	A	B	C	S1	S2
T	33.2	25.2	7.0	5.0	5.5
0	39.0	29.0	9.5	7.0	29.0
1	46.0	35.0	12.0	9.0	35.0
2	55.0	43.0	15.0	12.0	43.0

D2 Type

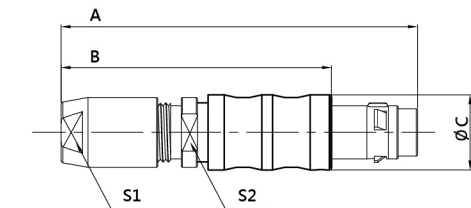

Standard back nut with bend relief

Size	Dimensions in mm				
	A	B	C	S1	S2
T	33.7	24.7	7.0	5.5	6.4
0	38.0	28.0	9.5	8.0	9.5
1	45.0	34.0	12.0	10.0	12.0
2	55.0	42.0	15.0	13.0	15.0

Unit : Millimeters. Dimensions for reference only.

Part Number & Spec. Description

R - F * * S * * 0 * C * * * *

STYLE

- TT= TT Size(2~4 contacts)
- 0T= 0T Size(2~12 contacts)
- 1T= 1T Size(2~16 contacts)
- 2T=2T Size(2~32 contacts)

NUMBER OF CONTACTS

- 02=02 contacts
- *****
- 32=32 contacts

CONTACT TYPE

- 2=Male solder contact
- 4=Female solder contact
- C=Crimp male contact
- M=Crimp female contact

CABLE OD

- 20=Ø 1.6mm-2.0mm
- 30=Ø 2.6mm-3.0mm
- 50=Ø 4.6mm-5.0mm
- *****
- 85=8.1mm-8.5mm

ALIGNMENT KEY

- 0= 0°
- *****
- U=145°

BACK NUT

- 1=Nut with bend relief
- 2=Standard nut

Note 1. Back nut material is same as outer shell.
Note 2. Insert configuration & operating voltage, please see page. 57. **A**
Alignment key, please see page.58. **B**
Note 3. Cable O.D, please see page 61. **E**

Metal T Series

SnapLatch Fixed Socket



Features

- Size TT, OT, 1T, 2T
- Locking system: Push-Pull
- Multipole 2 to 32 contacts
- Solder cup contacts
- Touch & Scoop proof
- High density for space savings
- Multiple key options to avoid cross mating

Technical Data

Material

- Outer Shell : Copper alloy plating Cr
- Insulator : polyetheretherketone UL 94V-0(Peek)
- Contact : Copper alloy plating Ni

Environmental

- IP67 when mated
- Working temp.: -55°C, +200°C

Mechanical

- Mating cycle : >3000 cycles

Metal K Series

SnapLatch Straight



Features

- Size 0K, 1K, 2K
- Locking system: Push-Pull
- Multipole 2 to 32 contacts
- Solder cup, crimp contacts
- Multiple key options to avoid cross mating
- Cable diameter: Ø1.0mm to 8.5mm

Technical Data

Material

- Outer Shell & back nut: brass plating Cr
- Insulator: polyetheretherketone UL 94V-0(Peek)
- Contact: Copper alloy plating Au
- Other metallic components: Brass plating Ni

Environmental

- IP66/ IP68 when mated
- Working temp.: -55°C~+200°C

Mechanical

- Mating cycle: >5000 cycles

T Series

R Type

Size	Dimensions in mm									
	A	B	C	D	E	F	G	S1	S2	
TT	10.0	10.2	M7x0.5	16.0	13.5	1.2	5.5	9.0	6.3	
OT	12.0	12.5	M9x0.6	21.0	19.1	1.5	6.0	11	8.2	
1T	15.5	16.0	M12x1.0	23.0	21.5	1.8	6.0	14.0	10.5	
2T	18.5	19.6	M15x1.0	26.5	24.6	1.8	7.5	17	13.5	

Unit : Millimeters. Dimensions for reference only.

K Series

C2 Type

C1 Type

Straight back unt

Size	Dimensions in mm			
	A	B	C	D
0	34.0	23.0	8.0	11.0
1	42.0	28.0	9.0	13.0
2	52.0	36.0	12.0	16.0

Straight back unt with bend relief

Size	Dimensions in mm			
	A	B	C	D
0	34.0	23.0	7.0	11.0
1	42.0	28.0	9.0	13.0
2	52.0	36.0	12.0	16.0

Unit : Millimeters. Dimensions for reference only.

Part Number & Spec. Description

R - F * * R * * 0 * 0 0 * 0 0

STYLE
 TT= TT Size(2~4 contacts)
 OT= OT Size(2~12 contacts)
 1T= 1T Size(2~16 contacts)
 2T=2T Size(2~32 contacts)

NUMBER OF CONTACTS
 02=2 contacts
 ~~*
 32=32 contacts

NUMBER OF CONTACTS
 2=Male solder contact C=Crimp male contact
 4=Female solder contact M=Crimp female contact

ALIGNMENT KEY
 0= 0°
 ~~*
 U=145°

Note 1. Insert configuration & operating voltage, please see page. 57. **A**
 Alignment key, please see page.58. **B**

Part Number & Spec. Description

R - F * * S * * 0 * C * * * *

SIZE
 0K=0K Size(2~9 contacts)
 1K=1K Size(2~16 contacts)
 2K=2K Size(2~32 contacts)

NUMBER OF CONTACTS
 02=02 contacts
 ~~*
 32=32 contacts

CONTACTS TYPE
 2= Male solder contact C= Male crimp contact
 4= Female solder contact M= Female crimp contact

CABLE O.D.
 10= O.D.(1.0mm~1.2mm)
 15= O.D.(1.3mm~1.5mm)
 ~~*
 85= O.D.(8.11mm~8.5mm)

ALIGNMENT KEY
 0= 0°
 ~~*
 U=145°

BACK NUT
 1= Nut with bend relief
 2= Standard nut

Note 1. Back nut material is same as outer shell.
 Note 2. Insert configuration & operating voltage, please see page 57. **A**
 Alignment key, please see page 58. **B**
 Note 3. Cable O.D, please see page 62. **E**

Metal K Series

SnapLatch Elbow Straight Plug



Features

- Size 0K, 1K
- Locking system: Push-Pull
- Multipole 2 to 16 contacts
- Solder cup, crimp contacts
- Multiple key options to avoid cross mating
- Cable diameter: Ø1.0mm to 8.5mm

Technical Data

Material

- Outer Shell & back nut: Copper alloy plating Cr
- Insulator : polyetheretherketone UL 94V-0(Peek)
- Contact : Copper alloy plating Au
- Other metallic components: Brass plating Ni

Environmental

- IP66/IP68 when mated
- Working temp.: -55°C ~ +200°C

Mechanical

- Mating cycle: >5000 cycles

Metal K Series

SnapLatch Free Socket



Features

- Size 0K, 1K, 2K
- Locking system: Push-Pull
- Multipole 2 to 32 contacts
- Solder cup, crimp contacts
- Multiple key options to avoid cross mating
- Cable diameter: Ø1.0mm to 8.5mm

Technical Data

Material

- Outer Shell & back nut: Copper alloy plating Cr
- Insulator: polyetheretherketone UL 94V-0(Peek)
- Contact: Copper alloy plating Au
- Other metallic components: Brass plating Ni

Environmental

- IP66/IP68 when mated
- Working temp.: -55°C ~ +200°C

Mechanical

- Mating cycle: >5000 cycles

C2 Type

Standard back nut

Size	Dimensions in mm							
	A	B	C	D	E	S1	S2	S3
0	11.0	25.0	36.0	27.0	7.6	10.0	8.0	8.0
1	13.0	29.0	43.0	33.0	8.8	12.0	9.0	10.0

C1 Type

Standard back nut with bend relief

Size	Dimensions in mm							
	A	B	C	D	E	S1	S2	S3
0	11.0	25.0	36.0	27.0	7.6	10.0	7.0	8.0
1	13.0	29.0	43.0	37.3	8.8	12.0	9.0	10.0

Unit : Millimeters. Dimensions for reference only.

C2 Type

Standard back nut

Size	Dimensions in mm		
	A	B	C
0	34.0	8.0	13.0
1	45.0	9.0	15.0
2	54.0	12.0	19.0

C1 Type

Standard back nut with bend relief

Size	Dimensions in mm		
	A	B	C
0	34.0	7.0	13.0
1	45.0	9.0	15.0
2	54.0	12.0	19.0

Unit : Millimeters. Dimensions for reference only.

Part Number & Spec. Description

R - F * * H * * 0 * C * * * *

SIZE

0K=0K Size(2~9 contacts)
1K=1K Size(2~16 contacts)

NUMBER OF CONTACTS

02=02 contacts
~~*~*
16=16 contacts

CONTACTS TYPE

2= Male solder contact C=Crimp male contact
4= Female solder contact M=Crimp female contact

CABLE O.D.

10=Ø 1.0mm-1.2mm
15=Ø 1.3mm-1.5mm
20=Ø 1.6mm-2.0mm
25=Ø 2.1mm-2.5mm
~~*~*
65=Ø 6.1mm-6.5mm

ALIGNMENT KEY

0= 0°
~~*~*
U=145°

BACK NUT

1=Nut with bend relief
2=Standard nut

Note 1. Back nut material is same as outer shell.
Note 2. Insert configuration & operating voltage, please see page. 57. **A**
Alignment key, please see page.58. **B**
Note 3. Cable O.D, please see page 62. **E**

Part Number & Spec. Description

R - F * * F * * 0 * C * * * *

SIZE

0K=0K Size(2~9 contacts)
1K=1K Size(2~16 contacts)
2K=2K Size(2~32 contacts)

NUMBER OF CONTACTS

02=02 contacts
~~*~*
32=32 contacts

CONTACTS TYPE

2= Male solder contact C= Crimp male contact
4= Female solder contact M=Crimp female contact

CABLE O.D.

10=Ø 1.0mm-1.2mm
15=Ø 1.3mm-1.5mm
20=Ø 1.6mm-2.0mm
~~*~*
85=Ø 8.1mm-8.5mm

ALIGNMENT KEY

0= 0°
~~*~*
U= 145°

BACK NUT

1=Nut with bend relief
2=Standard nut

Note 1. Back nut material is same as outer shell.
Note 2. Insert configuration & operating voltage, please see page. 57. **A**
Alignment key, please see page.58. **B**
Note 3. Cable O.D, please see page 62. **E**

Metal K Series

SnapLatch Fixed Socket



Features

- Size 0K, 1K, 2K
- Locking system: Push-Pull
- Multipole 2 to 32 contacts
- Solder cup, crimp contacts
- Multiple key options to avoid cross mating

Technical Data

Material

- Outer shell : Copper alloy plating Cr
- Insulator : polyetheretherketone UL 94V-0(Peek)
- Contact : Copper alloy plating Au
- Other metallic components: Brass plating Ni

Environmental

- IP66/IP68 when mated
- Working temp.: -55°C ~ +200°C

Mechanical

- Mating cycle: >5000 cycles

Metal S Series

SnapLatch Straight Plug and Fixed Socket



Features

- Locking System: Push-Pull
- Size 0S
- Multipole 2 to 4 contacts
- Solder cup, crimp contacts
- Cable diameter: Ø1.3mm to 4.4mm

Technical Data

Material

- Outer Shell & back nut: Copper alloy plating Cr
- Insulator: polyetheretherketone UL 94V-0(Peek)
- Contact: Copper alloy plating Au

Environmental

- IP50 when mated
- Working temp.: -50°C ~ +250°C

Mechanical

- Mating cycle: >5000 cycles

K Series

R Type

Fixed socket, Nut fixing

Size	Dimensions in mm				
	A	B	C	D	E
0	21.7	19.2	M14X1.0	17.0	18.0
1	27.0	21.5	M16X1.0	19.0	20.0
2	30.7	27.0	M20X1.0	24.0	25.0

N Type

Fixed socket, back panel mounting

Size	Dimensions in mm			
	A	B	C	D
0	21.7	18.0	M14X1.0	18.0
1	27.0	20.0	M16X1.0	20.0
2	30.7	25.0	M20X1.0	25.0

Unit : Millimeters. Dimensions for reference only.

S Series

S Type

N Type

Unit : Millimeters. Dimensions for reference only.

Part Number & Spec. Description

R - F * * * * 0 * 0 0 * 0 0

SIZE

0K=0K Size(2~9 contacts)
 1K=1K Size(2~16 contacts)
 2K=2K Size(2~32 contacts)

STYLE

R= Receptacle
 N= Receptacle and back panel mounting

NUMBER OF CONTACTS

02=02 contacts
 ~~*~
 32=32 contacts

ALIGNMENT KEY

0= 0°
 ~~*~
 U= 145°

CONTACTS TYPE

1= Male print contact
 2= Male solder contact
 3= Female print contact
 4= Female solder contact
 C= Male crimp contact
 M= Female crimp contact

Note 1. Insert configuration & operating voltage, please see page.57. **A**
 Alignment key, please see page.58 **B**

Part Number & Spec. Description

R - F 0 S * * * 0 * * * 0 * *

STYLE

S= Straight Plug
 N= Receptacle with two nut

NUMBER OF CONTACTS

02=02 contacts 04=04 contacts
 03=03 contacts

CONTACTS TYPE

2= Male solder contact C= Male crimp contact
 3= Male print contact

CABLE O.D.

22= Ø 1.3mm-2.2mm
 32= Ø 2.2mm-3.2mm
 37= Ø 3.2mm-3.7mm
 44= Ø 3.7mm-4.4mm

BACK NUT

0=No nut (For receptacle)
 2=Standard nut

COLLECT TYPE

0=Blank(Only for receptacle)
 D=Collect Type

Note 1. Insert configuration, please see page. 56. **A**

Micro Series

Plug and Socket



Features

- Small contact size, 50 mm pitch
- $\varnothing 0.27$ " outer housing with 12 contacts max
- Flex-pin contacts, good for resisting vibration and shock
- Tail options for pre-wired, solder cup, and solid straight tail
- Wire harnesses, flex termination, over-molding and custom shells are all available upon request
- Cable diameter: $\varnothing 1.3$ mm to 4.4mm

Technical Data

Material

- Outer Shell : LCP
- Contact : Copper alloy plating Au

Environmental

- IP50 when mated
- Working temp.: -55°C ~ +125°C

Mechanical

- Mating cycle : > 500 cycles

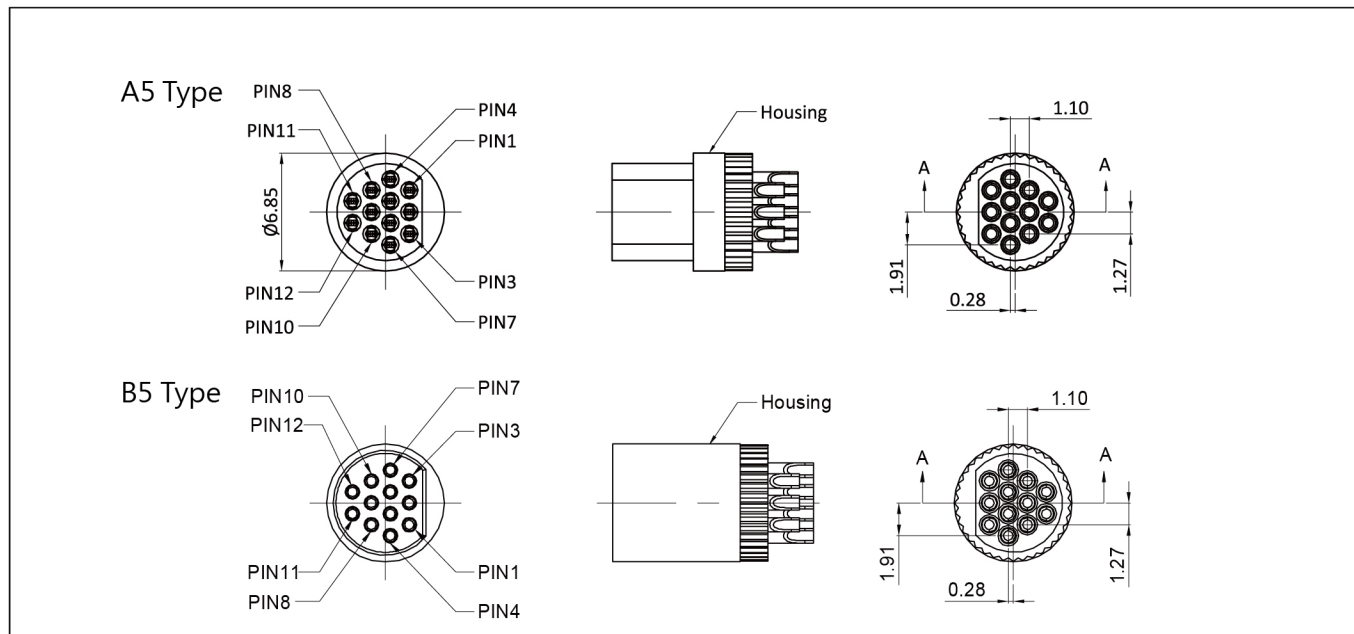

Unit : Millimeters. Dimensions for reference only.

Part Number & Spec. Description

R - M * * L O P * * 0 * * * 0

STYLE

- A5=Micro plug
- B5=Micro socket

HOUSING TYPE

- 0= Standard
- 1= With latch

NUMBER OF CONTACT

- 04=4 contacts
- 07=7 contacts
- 10=10 contacts
- 12=12 contacts

LATCH

- 0= No latch part
- 1= With latch part

CONTACT TYPE

- 2= Solder cup contact
- 3= Print contact

Accessories

Bend Relief Type-1P & 2P Series

For Plastic 1P Series

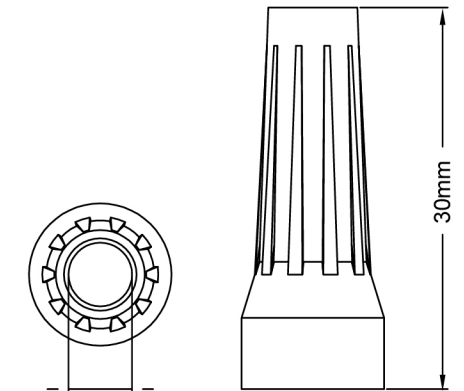

Material: Silicone
Temperature range: -50°C ~ 200°C

ZMD1S***0

Color Option

Color Code	Color
0	Black
2	Red
3	White
4	Yellow
5	Green
6	Blue
8	Grey

DIM.A of Cable O.D.

$\varnothing 2.5$ mm~ $\varnothing 3.0$ mm	025
$\varnothing 3.0$ mm~ $\varnothing 3.5$ mm	030
$\varnothing 3.5$ mm~ $\varnothing 4.0$ mm	035
$\varnothing 4.0$ mm~ $\varnothing 4.5$ mm	040
$\varnothing 4.5$ mm~ $\varnothing 5.0$ mm	045
$\varnothing 5.0$ mm~ $\varnothing 5.5$ mm	050
$\varnothing 5.5$ mm~ $\varnothing 6.0$ mm	055
$\varnothing 6.0$ mm~ $\varnothing 6.5$ mm	060
$\varnothing 6.5$ mm~ $\varnothing 7.0$ mm	065

For Plastic 2P Series

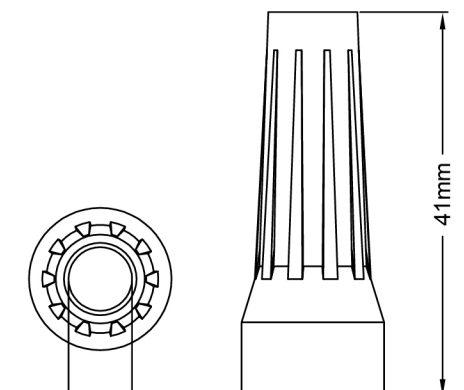

Material: Silicone
Temperature range: -50°C ~ 200°C

Z - MD4S*0000***0

Color Option

Definition	Code
Black	0
Red	2
White	3
Yellow	4
Green	5
Blue	6
Grey	8

DIM.A of Cable O.D.

$\varnothing 4.0$ mm~ $\varnothing 4.4$ mm	040
$\varnothing 4.5$ mm~ $\varnothing 5.0$ mm	045
$\varnothing 5.1$ mm~ $\varnothing 5.6$ mm	051
$\varnothing 5.7$ mm~ $\varnothing 6.2$ mm	057
$\varnothing 6.3$ mm~ $\varnothing 7.0$ mm	063
$\varnothing 7.1$ mm~ $\varnothing 7.9$ mm	071
$\varnothing 8.0$ mm~ $\varnothing 9.0$ mm	080

Accessories

Bend Relief Type - B & K Series

For Metal Series

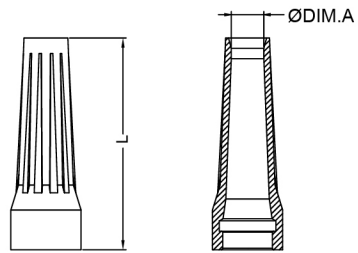
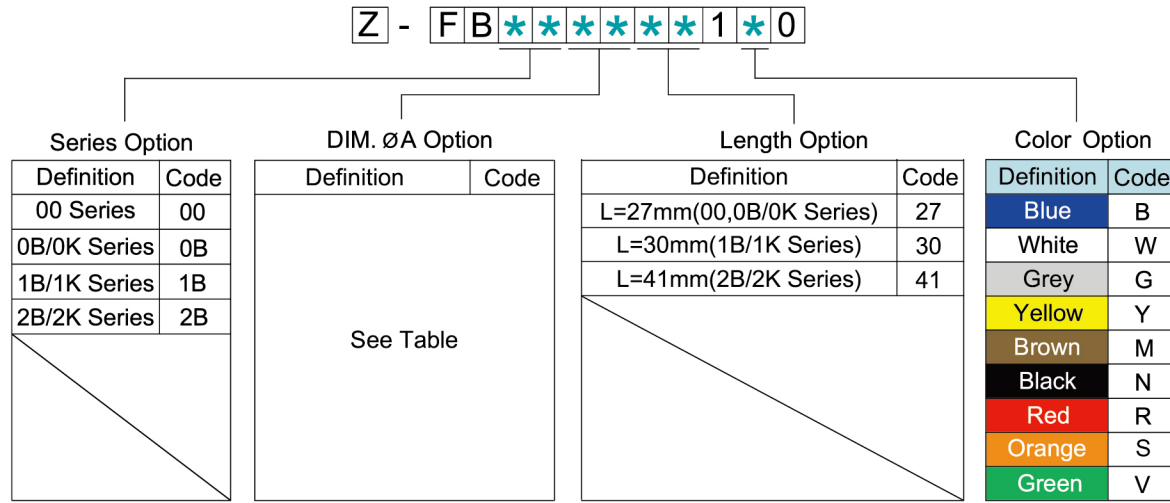

00 Series DIM.A of Cable O.D.	Code
1.1mm-1.4mm	12
1.8mm-1.4mm	18
2.5mm-2.8mm	25
2.8mm-3.1mm	28
3.2mm-3.5mm	32

0B/0K Series DIM.A of Cable O.D.	Code
2.5mm-2.9mm	25
3.0mm-3.4mm	30
3.5mm-3.9mm	35
4.0mm-4.4mm	40
4.5mm-5.2mm	45

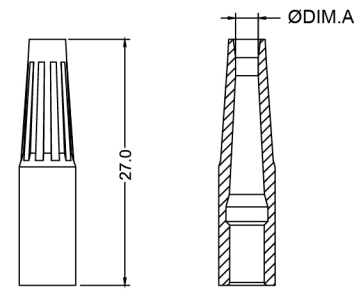

1B/1K Series DIM.A of Cable O.D.	Code
2.5mm-3.0mm	25
3.0mm-3.5mm	30
3.5mm-4.0mm	35
4.0mm-4.5mm	40
4.5mm-5.0mm	45
5.1mm-5.5mm	50
5.5mm-6.0mm	55
6.0mm-6.5mm	60
6.5mm-7.0mm	65
7.0mm-7.5mm	70

2B/2K Series DIM.A of Cable O.D.	Code
4.0mm-4.4mm	40
4.5mm-5.0mm	45
5.1mm-5.6mm	51
5.7mm-6.2mm	57
6.3mm-7.0mm	63
7.1mm-7.9mm	71
8.0mm-9.0mm	80

Accessories

Protective Cap & Dustproof Cap

PLUG PROTECTIVE CAP SOCKET PROTECTIVE CAP

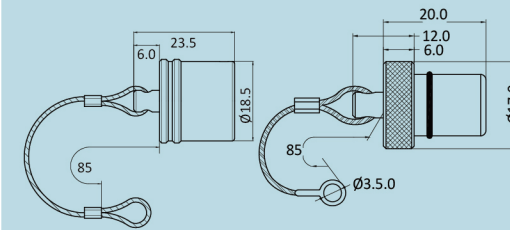

- B series**
- Outer shell & Ferrule: Copper alloy plating Cr
 - Lanyard: Stainless steel
 - Crimp ferrule: Aluminium alloy
 - O-ring: Silicone rubber
 - Maximum operating temperature: 135°C
 - Watertightness: IP61
 - Compliant with the RoHS Directive
 - Alignment key: Please see page.xx B

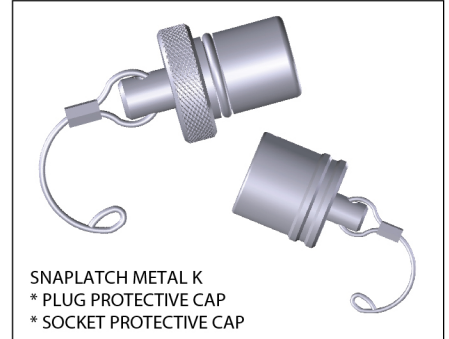

PLUG PROTECTIVE CAP SOCKET PROTECTIVE CAP

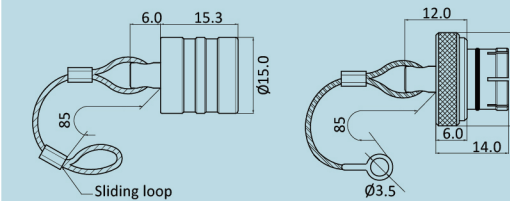

- K series**
- Outer shell: Copper alloy plating Cr
 - Lanyard material: Stainless steel
 - Crimp ferrule: Aluminium alloy
 - O-ring material: Silicone rubber or FPM
 - Maximum operating temperature: 135°C
 - Watertightness: IP68
 - Compliant with the RoHS Directive

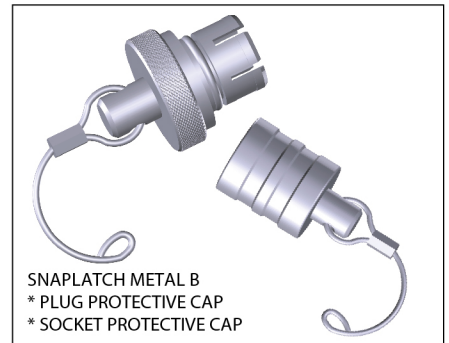

Receptacle Dust-Proof Cap

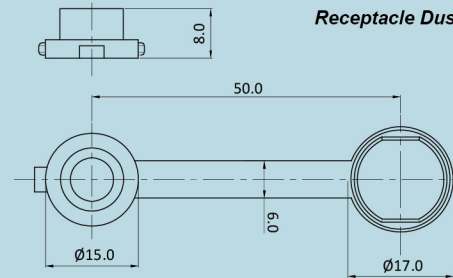

- 1P Series**
- Material: Silicone
 - Color: Black
 - Gender: Female
 - Cost-saving.
 - Flammability Rating UL 94V-0.
 - Compliant with the RoHS Directive



Tools

Spanner

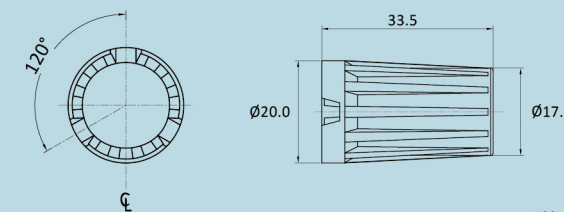

- Material: High temperature plastic, UL94-V0
- Compliant with the RoHS Directive

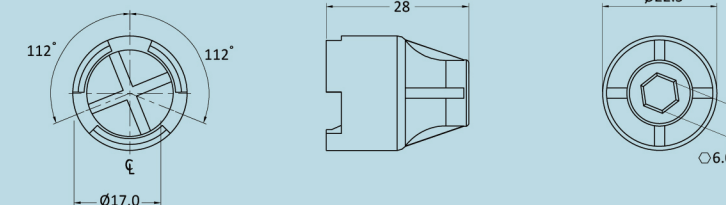





- Material: High temperature plastic, UL94-V0
- Compliant with the RoHS Directive

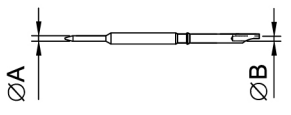

Appendix

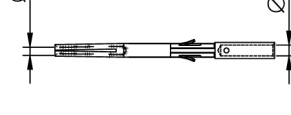
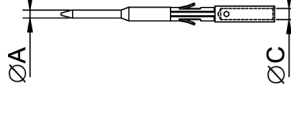
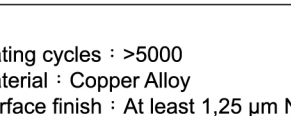
Contact Type for All Series

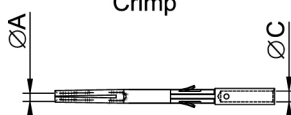
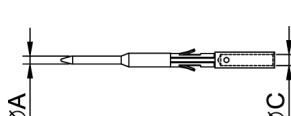
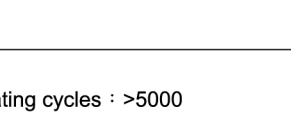

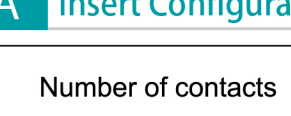
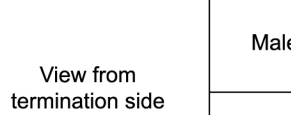

















Soldercup		Contact ∅A (mm)	Solder bucket ∅B (mm)	Max. AWG / mm ²
		0.5	0.45	28/0.09
		0.7	0.80	24/0.65
		0.9	0.80	22/0.34
		1.3	1.00	20/0.50
		1.6	1.40	16/1.00
		2.0	1.80	14/1.50

Crimp		Contact ∅A (mm)	Contact ∅C (mm)	Max. AWG / mm ²
		0.5	0.45	28/0.09
		0.7	0.80	24/0.65
		0.9	1.10	20/0.50
		1.3	1.40	18/1.00
		1.6	1.90	14/1.50
		2.0	2.40	12/2.50

Mating cycles : >5000
 Material : Copper Alloy
 Surface finish : At least 1,25 μm Ni; at least 0.50 μm Au

1P Series

A Insert Configuration







Number of contacts		02	03	04	05	06	07	08	09	10	14
View from termination side	Male										
	Female										
Test voltage(kv rms)		1.2	1.2	1.2	1.05	1.05	1.05	1.05	0.85	0.85	0.6
Rated current		10	10	8	7	6	5	5	3	3	2
Creepage and clearance distance(mm)		1.3	1.3	1.2	0.8	0.85	0.85	0.6	0.65	0.5	0.5
Cable MAX. AWG		20	20	22	22	26	26	26	28	28	28
Solder bucket ∅(mm)		1.1	1.1	0.85	0.85	0.65	0.65	0.65	0.45	0.45	0.45
Contact ∅(mm)		1.3	1.3	0.9	0.9	0.7	0.7	0.7	0.5	0.5	0.5

The above shown test voltage corresponds to 75% of the mean breakdown voltage.
 Operating voltage is suggested to be 1/3 of the shown test voltage.

Appendix

1P Series

B Alignment Key

Coding	0	A	C	E	H	S	J
Plug front view							

C Panel Cutout For Socket

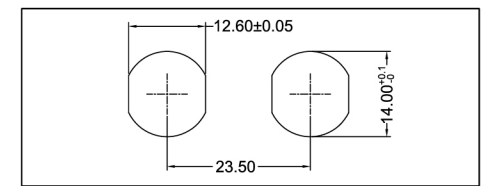

D PCB Drilling

For straight contacts

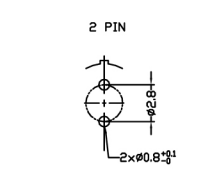
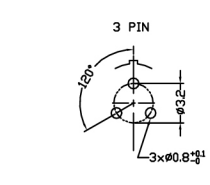
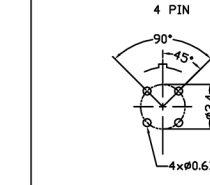
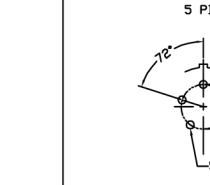
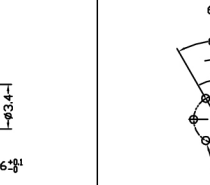
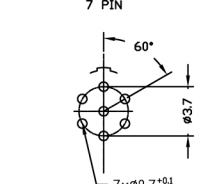
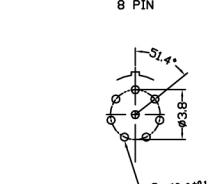
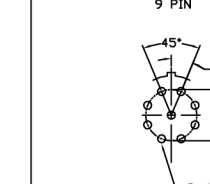
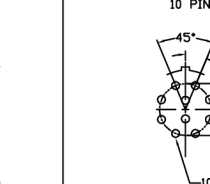
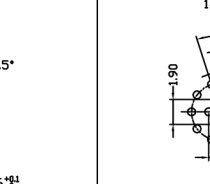
For 90° Elbow contacts B3 type

Appendix

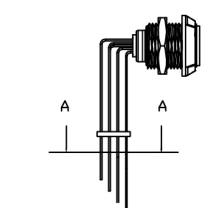
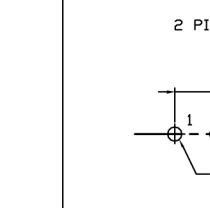
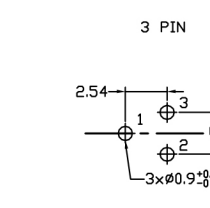
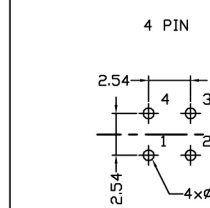
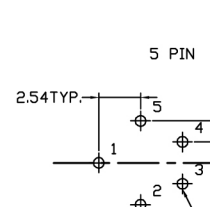
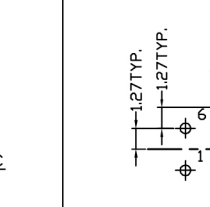
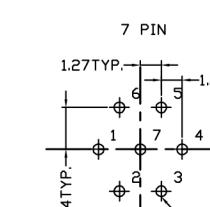
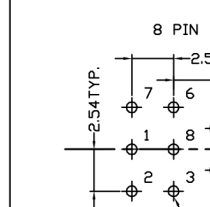
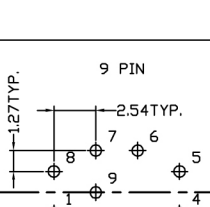
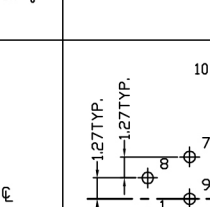
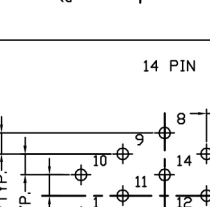
2P Series

A Insert Configuration

Number of contacts		02	03	04	05	06	07	08	10	12	16	19	26	32	34
View from termination side	Male														
	Female														
Test voltage(kv rms)		2.10	2.40	1.85	1.75	1.35	1.75	1.50	1.45	1.25	1.50	1.40	1.00	0.70	0.70
Air Clearance(mm) Creepage Distance(mm)		1.60	1.50	1.80	1.10	0.85	0.95	1.00	0.75	0.85	0.65	0.60	0.50	0.30	0.30
Rated Current(A)		30.00	17.00	15.00	14.00	12.00	11.00	10.00	8.00	7.00	6.00	5.00	2	1.50	1.50
AWG MAX		16	18	22	22	22	22	26	26	26	26	26	28	28	28
Solder bucket Ø(mm)		1.8	1.4	1.0	1.0	1.0	1.0	0.8	0.8	0.8	0.8	0.8	0.4	0.4	0.4
Contact Ø(mm)		2.0	1.6	1.3	1.3	1.3	1.3	0.9	0.9	0.7	0.7	0.7	0.5	0.5	0.5

The above shown Test voltage corresponds to 75% of the mean breakdown voltage.
Operating voltage is suggested to be 1/3 of the shown Test voltage.

B Alignment Key

Coding	B	H	J	C	S
Plug front view					

C Panel Cutout for Socket

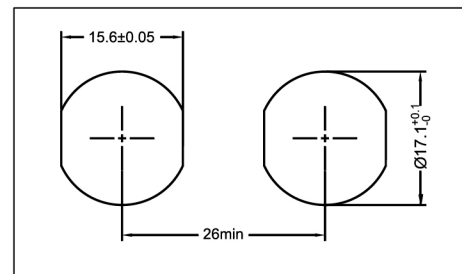

D PCB Drilling

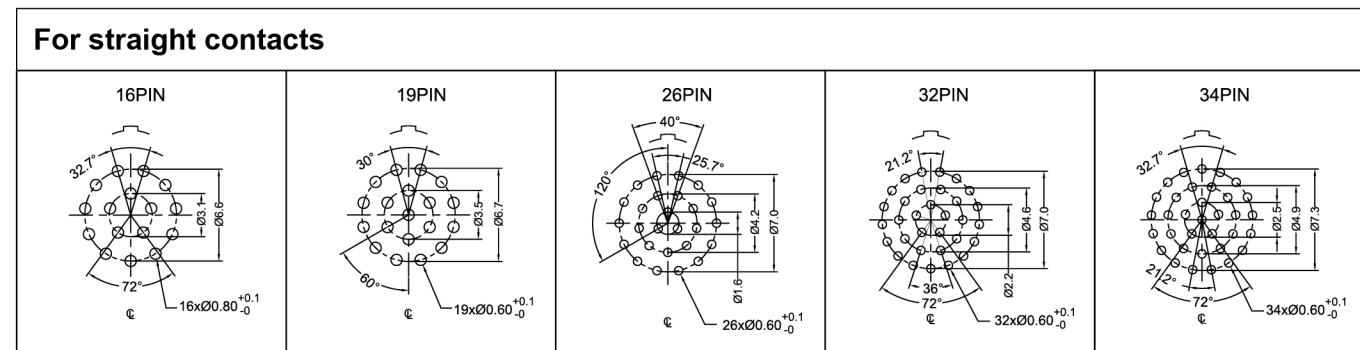

Appendix

1P & 2P Series

E Collet & Back nut Type

Collet Type	Size	Collet code	Cable Ø		Standard Nut	Nut with relief	
			Collect Ø	Min.			Max.
			ØA				
1P	1	1	3.9	2.7	3.9		
	2	2	5.2	4.0	5.2		
	3	3	6.5	5.3	6.5		
2P	1	1	5.2	3.2	5.2		
	2	2	7.2	5.3	7.2		
	3	3	9.2	7.3	9.2		

S Series

A Insert Configuration

Type	02	03	04
Plug			
Socket			

B Panel Cutout for Socket

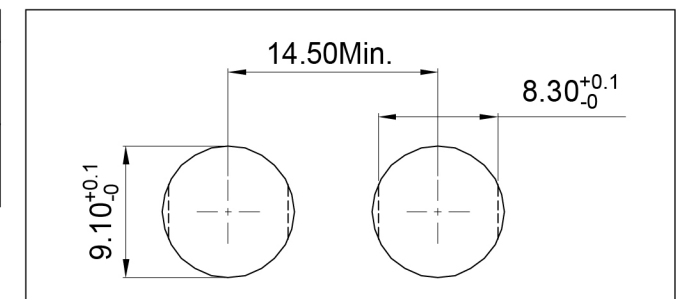

C PCB Drilling

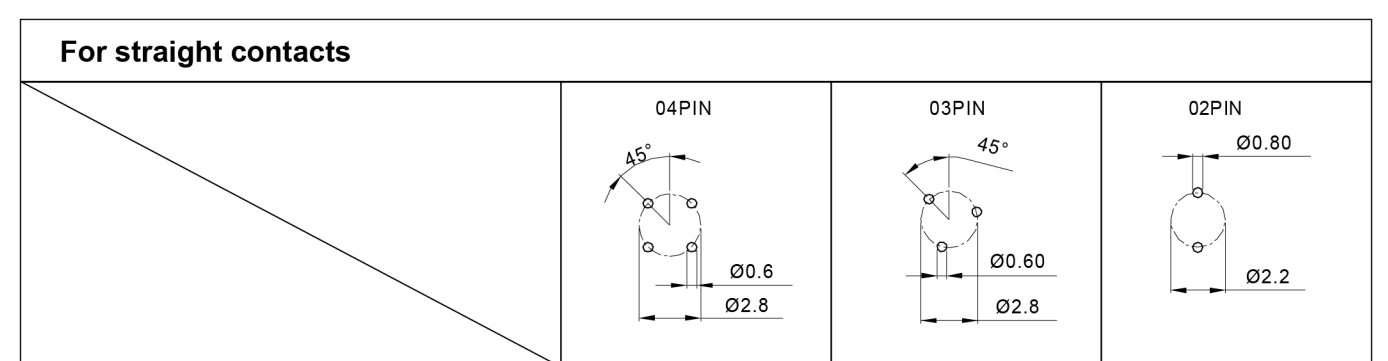

Appendix

B, K, T Series

A Insert Configuration

Type	00 / TT			Type	0B / 0K / 0T							
Male				Male								
Female				Female								
Contact Code	02	03	04	Contact Code	02	03	04	05	06	07	08	09
No. of Contacts	2	3	4	No. of Contacts	2	3	4	5	6	7	8	9
ContactsØ(mm)	0.5	0.5	0.5	ContactsØ(mm)	0.9	0.9	0.7	0.7	0.5	0.5	0.5	0.5
Test Voltage (kv rms)	1.0	0.8	0.80	Test Voltage (kv rms)	1.0	1.2	0.85	1.00	0.85	0.80	0.80	0.60
Current (A)	3.5	3	2	Current (A)	10	8	7	6.5	2.5	2.5	2	2

Type	1B / 1K / 1T									
Male										
Female										
Contact Code	02	03	04	05	06	07	08	10	14	16
No. of Contacts	2	3	4	5	6	7	8	10	14	16
ContactsØ(mm)	1.3	1.3	0.9	0.9	0.7	0.7	0.7	0.5	0.5	0.5
Test Voltage (kv rms)	1.50	1.30	1.35	1.25	1.05	0.95	0.95	0.90	0.80	0.80
Current (A)	15	12	10	9	7	7	5	2.5	2	1.5

Type	2B / 2K / 2T													
Male														
Female														
Contact Code	02	03	04	05	06	07	08	10	12	14	16	18	19	26
No. of Contacts	2	3	4	5	6	7	8	10	12	14	16	18	19	26
ContactsØ(mm)	2.0	1.6	1.3	1.3	1.3	1.3	0.9	0.9	0.7	0.7	0.7	0.7	0.7	0.5
Test Voltage (kv rms)	2.10	2.40	1.85	1.75	1.35	1.75	1.50	1.45	1.25	1.15	0.95	0.85	0.95	0.80
Current (A)	25	17	15	14	12	11	10	8	7	6.5	6	5.5	5	2

The above shown Test voltage corresponds to 75% of the mean breakdown voltage. Operating voltage is suggested to be 1/3 of the shown Test voltage.

Appendix

B, K, T Series

B Alignment Key

B series		a										b				c				d
Part No.		0	A	D	B	C	E	F	K	M	U	X	J	H	S	P	Z	Q		
Angles		0°	30°	45°	60°	90°	37.5°	52.5°	120°	135°	145°	155°	45°	70°	75°	80°	95°	110°		
SIZE	00	●	●		●								●		●					
	0B	●	●		●	●				●	●	●	●	●	●	●		●		
	1B	●	●		●	●				●	●	●	●	●	●	●				
	2B	●	●	●	●		●	●	●		●			●	●			●		

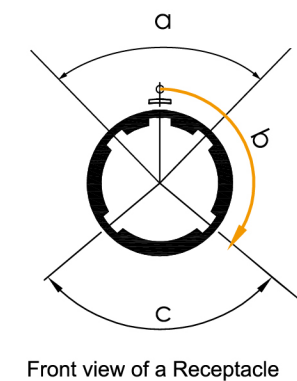
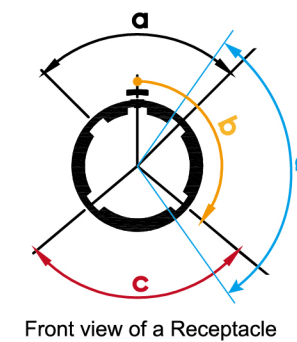

T Series		a				b			c		
Part No.		0	A	B	D	K	M	U	H	L	C
Angles		0°	30°	60°	45°	120°	135°	145°	75°	80°	95°
SIZE	TT	●	●								
	0T	●	●		●		●			●	
	1T	●	●		●		●			●	
	2T	●	●	●	●	●		●	●		●

K series		a					b		c	
Part No.		0	A	D	B	S	K	U	H	C
Angles		0°	30°	45°	60°	90°	120°	145°	75°	95°
SIZE	0K	●	●	●	●	●	●	●	●	●
	1K	●	●	●	●	●	●	●	●	●
	2K	●	●	●	●	●	●	●	●	●

C Panel Cutout For Socket

K series			
	A	B	C
0K	20.5	14.1	12.6
1K	22.5	16.1	14.6
2K	29.0	20.2	18.6

B / T series			
	A	B	C
00 / TT	12.5	7.1	6.4
0T / 0B	14.5	9.1	8.3
1T / 1B	18.5	12.1	10.6
2T / 2B	22.5	15.1	13.6

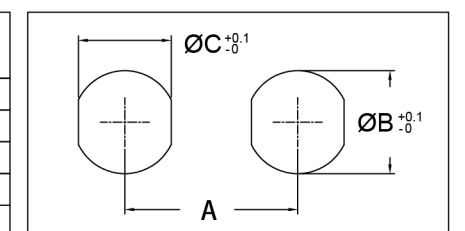



Appendix

B, K, T Series

D PCB Drilling Pattern

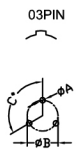
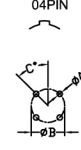
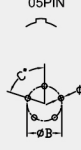
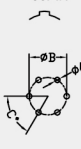
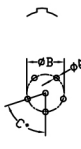
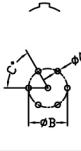
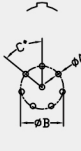
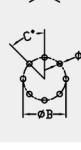
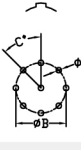
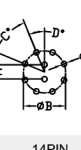
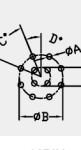

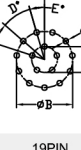
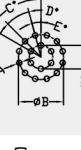
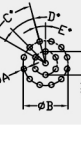
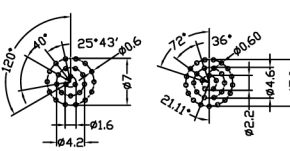
Fixed socket with straight print contact

<p>02PIN</p>  <table border="1"> <thead> <tr> <th rowspan="2">Series</th> <th colspan="2">Dimensions</th> </tr> <tr> <th>A</th> <th>B</th> </tr> </thead> <tbody> <tr> <td>00 / TT</td> <td>0.6</td> <td>1.2</td> </tr> <tr> <td>0B / 0K / 0T</td> <td>0.8</td> <td>2.2</td> </tr> <tr> <td>1B / 1K / 1T</td> <td>0.8</td> <td>2.8</td> </tr> <tr> <td>2B / 2K / 2T</td> <td>0.8</td> <td>4.4</td> </tr> </tbody> </table>	Series	Dimensions		A	B	00 / TT	0.6	1.2	0B / 0K / 0T	0.8	2.2	1B / 1K / 1T	0.8	2.8	2B / 2K / 2T	0.8	4.4	<p>03PIN</p>  <table border="1"> <thead> <tr> <th rowspan="2">Series</th> <th colspan="3">Dimensions</th> </tr> <tr> <th>A</th> <th>B</th> <th>C</th> </tr> </thead> <tbody> <tr> <td>00 / TT</td> <td>0.6</td> <td>1.35</td> <td>120°</td> </tr> <tr> <td>0B / 0K / 0T</td> <td>0.8</td> <td>2.3</td> <td>120°</td> </tr> <tr> <td>1B / 1K / 1T</td> <td>0.8</td> <td>3.0</td> <td>120°</td> </tr> <tr> <td>2B / 2K / 2T</td> <td>0.8</td> <td>4.6</td> <td>120°</td> </tr> </tbody> </table>	Series	Dimensions			A	B	C	00 / TT	0.6	1.35	120°	0B / 0K / 0T	0.8	2.3	120°	1B / 1K / 1T	0.8	3.0	120°	2B / 2K / 2T	0.8	4.6	120°							
Series		Dimensions																																														
	A	B																																														
00 / TT	0.6	1.2																																														
0B / 0K / 0T	0.8	2.2																																														
1B / 1K / 1T	0.8	2.8																																														
2B / 2K / 2T	0.8	4.4																																														
Series	Dimensions																																															
	A	B	C																																													
00 / TT	0.6	1.35	120°																																													
0B / 0K / 0T	0.8	2.3	120°																																													
1B / 1K / 1T	0.8	3.0	120°																																													
2B / 2K / 2T	0.8	4.6	120°																																													
<p>04PIN</p>  <table border="1"> <thead> <tr> <th rowspan="2">Series</th> <th colspan="3">Dimensions</th> </tr> <tr> <th>A</th> <th>B</th> <th>C</th> </tr> </thead> <tbody> <tr> <td>00 / TT</td> <td>0.6</td> <td>1.6</td> <td>45°</td> </tr> <tr> <td>0B / 0K / 0T</td> <td>0.6</td> <td>2.5</td> <td>45°</td> </tr> <tr> <td>1B / 1K / 1T</td> <td>0.8</td> <td>3.1</td> <td>45°</td> </tr> <tr> <td>2B / 2K / 2T</td> <td>0.8</td> <td>5.0</td> <td>45°</td> </tr> </tbody> </table>	Series	Dimensions			A	B	C	00 / TT	0.6	1.6	45°	0B / 0K / 0T	0.6	2.5	45°	1B / 1K / 1T	0.8	3.1	45°	2B / 2K / 2T	0.8	5.0	45°	<p>05PIN</p>  <table border="1"> <thead> <tr> <th rowspan="2">Series</th> <th colspan="3">Dimensions</th> </tr> <tr> <th>A</th> <th>B</th> <th>C</th> </tr> </thead> <tbody> <tr> <td>0B / 0K / 0T</td> <td>0.6</td> <td>2.8</td> <td>72°</td> </tr> <tr> <td>1B / 1K / 1T</td> <td>0.8</td> <td>3.4</td> <td>72°</td> </tr> <tr> <td>2B / 2K / 2T</td> <td>0.8</td> <td>5.2</td> <td>72°</td> </tr> </tbody> </table>	Series	Dimensions			A	B	C	0B / 0K / 0T	0.6	2.8	72°	1B / 1K / 1T	0.8	3.4	72°	2B / 2K / 2T	0.8	5.2	72°					
Series		Dimensions																																														
	A	B	C																																													
00 / TT	0.6	1.6	45°																																													
0B / 0K / 0T	0.6	2.5	45°																																													
1B / 1K / 1T	0.8	3.1	45°																																													
2B / 2K / 2T	0.8	5.0	45°																																													
Series	Dimensions																																															
	A	B	C																																													
0B / 0K / 0T	0.6	2.8	72°																																													
1B / 1K / 1T	0.8	3.4	72°																																													
2B / 2K / 2T	0.8	5.2	72°																																													
<p>06PIN</p>  <table border="1"> <thead> <tr> <th rowspan="2">Series</th> <th colspan="3">Dimensions</th> </tr> <tr> <th>A</th> <th>B</th> <th>C</th> </tr> </thead> <tbody> <tr> <td>0B / 0K / 0T</td> <td>0.6</td> <td>3.0</td> <td>60°</td> </tr> <tr> <td>1B / 1K / 1T</td> <td>0.8</td> <td>3.7</td> <td>60°</td> </tr> </tbody> </table>	Series	Dimensions			A	B	C	0B / 0K / 0T	0.6	3.0	60°	1B / 1K / 1T	0.8	3.7	60°	<p>06PIN</p>  <table border="1"> <thead> <tr> <th rowspan="2">Series</th> <th colspan="3">Dimensions</th> </tr> <tr> <th>A</th> <th>B</th> <th>C</th> </tr> </thead> <tbody> <tr> <td>2B / 2K / 2T</td> <td>0.8</td> <td>5.6</td> <td>72°</td> </tr> </tbody> </table>	Series	Dimensions			A	B	C	2B / 2K / 2T	0.8	5.6	72°																					
Series		Dimensions																																														
	A	B	C																																													
0B / 0K / 0T	0.6	3.0	60°																																													
1B / 1K / 1T	0.8	3.7	60°																																													
Series	Dimensions																																															
	A	B	C																																													
2B / 2K / 2T	0.8	5.6	72°																																													
<p>07PIN</p>  <table border="1"> <thead> <tr> <th rowspan="2">Series</th> <th colspan="3">Dimensions</th> </tr> <tr> <th>A</th> <th>B</th> <th>C</th> </tr> </thead> <tbody> <tr> <td>0B / 0K / 0T</td> <td>0.6</td> <td>3.0</td> <td>60°</td> </tr> <tr> <td>1B / 1K / 1T</td> <td>0.8</td> <td>3.7</td> <td>60°</td> </tr> <tr> <td>2B / 2K / 2T</td> <td>0.8</td> <td>5.8</td> <td>60°</td> </tr> </tbody> </table>	Series	Dimensions			A	B	C	0B / 0K / 0T	0.6	3.0	60°	1B / 1K / 1T	0.8	3.7	60°	2B / 2K / 2T	0.8	5.8	60°	<p>08PIN</p>  <table border="1"> <thead> <tr> <th rowspan="2">Series</th> <th colspan="3">Dimensions</th> </tr> <tr> <th>A</th> <th>B</th> <th>C</th> </tr> </thead> <tbody> <tr> <td>1B / 1K / 1T</td> <td>0.8</td> <td>3.8</td> <td>51°26'</td> </tr> </tbody> </table>	Series	Dimensions			A	B	C	1B / 1K / 1T	0.8	3.8	51°26'																	
Series		Dimensions																																														
	A	B	C																																													
0B / 0K / 0T	0.6	3.0	60°																																													
1B / 1K / 1T	0.8	3.7	60°																																													
2B / 2K / 2T	0.8	5.8	60°																																													
Series	Dimensions																																															
	A	B	C																																													
1B / 1K / 1T	0.8	3.8	51°26'																																													
<p>08PIN</p>  <table border="1"> <thead> <tr> <th rowspan="2">Series</th> <th colspan="3">Dimensions</th> </tr> <tr> <th>A</th> <th>B</th> <th>C</th> </tr> </thead> <tbody> <tr> <td>2B / 2K / 2T</td> <td>0.8</td> <td>6.4</td> <td>45°</td> </tr> </tbody> </table>	Series	Dimensions			A	B	C	2B / 2K / 2T	0.8	6.4	45°	<p>09PIN</p>  <table border="1"> <thead> <tr> <th rowspan="2">Series</th> <th colspan="3">Dimensions</th> </tr> <tr> <th>A</th> <th>B</th> <th>C</th> </tr> </thead> <tbody> <tr> <td>0B / 0K / 0T</td> <td>0.6</td> <td>3.2</td> <td>45°</td> </tr> </tbody> </table>	Series	Dimensions			A	B	C	0B / 0K / 0T	0.6	3.2	45°																									
Series		Dimensions																																														
	A	B	C																																													
2B / 2K / 2T	0.8	6.4	45°																																													
Series	Dimensions																																															
	A	B	C																																													
0B / 0K / 0T	0.6	3.2	45°																																													
<p>10PIN</p>  <table border="1"> <thead> <tr> <th rowspan="2">Series</th> <th colspan="5">Dimensions</th> </tr> <tr> <th>A</th> <th>B</th> <th>C</th> <th>D</th> <th>H</th> </tr> </thead> <tbody> <tr> <td>1B / 1K / 1T</td> <td>0.6</td> <td>3.95</td> <td>45°</td> <td>22°30'</td> <td>1.40</td> </tr> <tr> <td>2B / 2K / 2T</td> <td>0.8</td> <td>6.30</td> <td>45°</td> <td>22°30'</td> <td>2.15</td> </tr> </tbody> </table>	Series	Dimensions					A	B	C	D	H	1B / 1K / 1T	0.6	3.95	45°	22°30'	1.40	2B / 2K / 2T	0.8	6.30	45°	22°30'	2.15	<p>12PIN</p>  <table border="1"> <thead> <tr> <th rowspan="2">Series</th> <th colspan="5">Dimensions</th> </tr> <tr> <th>A</th> <th>B</th> <th>C</th> <th>D</th> <th>H</th> </tr> </thead> <tbody> <tr> <td>2B / 2K / 2T</td> <td>0.8</td> <td>6.5</td> <td>45°</td> <td>22°30'</td> <td>2.8</td> </tr> </tbody> </table>	Series	Dimensions					A	B	C	D	H	2B / 2K / 2T	0.8	6.5	45°	22°30'	2.8							
Series		Dimensions																																														
	A	B	C	D	H																																											
1B / 1K / 1T	0.6	3.95	45°	22°30'	1.40																																											
2B / 2K / 2T	0.8	6.30	45°	22°30'	2.15																																											
Series	Dimensions																																															
	A	B	C	D	H																																											
2B / 2K / 2T	0.8	6.5	45°	22°30'	2.8																																											
<p>14PIN</p>  <table border="1"> <thead> <tr> <th rowspan="2">Series</th> <th colspan="4">Dimensions</th> </tr> <tr> <th>A</th> <th>B</th> <th>H</th> <th>I</th> </tr> </thead> <tbody> <tr> <td>1B / 1K / 1T</td> <td>0.6</td> <td>4.4</td> <td>1.90</td> <td>1.80</td> </tr> <tr> <td>2B / 2K / 2T</td> <td>0.8</td> <td>6.5</td> <td>2.65</td> <td>2.65</td> </tr> </tbody> </table>	Series	Dimensions				A	B	H	I	1B / 1K / 1T	0.6	4.4	1.90	1.80	2B / 2K / 2T	0.8	6.5	2.65	2.65	<p>16PIN</p>  <table border="1"> <thead> <tr> <th rowspan="2">Series</th> <th colspan="4">Dimensions</th> </tr> <tr> <th>A</th> <th>B</th> <th>C</th> <th>H</th> </tr> </thead> <tbody> <tr> <td>1B / 1K / 1T</td> <td>0.6</td> <td>4.4</td> <td>32°44'</td> <td>2.0</td> </tr> </tbody> </table>	Series	Dimensions				A	B	C	H	1B / 1K / 1T	0.6	4.4	32°44'	2.0														
Series		Dimensions																																														
	A	B	H	I																																												
1B / 1K / 1T	0.6	4.4	1.90	1.80																																												
2B / 2K / 2T	0.8	6.5	2.65	2.65																																												
Series	Dimensions																																															
	A	B	C	H																																												
1B / 1K / 1T	0.6	4.4	32°44'	2.0																																												
<p>16PIN</p>  <table border="1"> <thead> <tr> <th rowspan="2">Series</th> <th colspan="5">Dimensions</th> </tr> <tr> <th>A</th> <th>B</th> <th>C</th> <th>D</th> <th>H</th> </tr> </thead> <tbody> <tr> <td>2B / 2K / 2T</td> <td>0.8</td> <td>6.6</td> <td>32°44'</td> <td>16°22'</td> <td>3.1</td> </tr> </tbody> </table>	Series	Dimensions					A	B	C	D	H	2B / 2K / 2T	0.8	6.6	32°44'	16°22'	3.1	<p>18PIN</p>  <table border="1"> <thead> <tr> <th rowspan="2">Series</th> <th colspan="6">Dimensions</th> </tr> <tr> <th>A</th> <th>B</th> <th>C</th> <th>D</th> <th>E</th> <th>H</th> </tr> </thead> <tbody> <tr> <td>2B / 2K / 2T</td> <td>0.8</td> <td>6.7</td> <td>60°</td> <td>30°</td> <td>15°</td> <td>3.5</td> </tr> </tbody> </table>	Series	Dimensions						A	B	C	D	E	H	2B / 2K / 2T	0.8	6.7	60°	30°	15°	3.5										
Series		Dimensions																																														
	A	B	C	D	H																																											
2B / 2K / 2T	0.8	6.6	32°44'	16°22'	3.1																																											
Series	Dimensions																																															
	A	B	C	D	E	H																																										
2B / 2K / 2T	0.8	6.7	60°	30°	15°	3.5																																										
<p>19PIN</p>  <table border="1"> <thead> <tr> <th rowspan="2">Series</th> <th colspan="6">Dimensions</th> </tr> <tr> <th>A</th> <th>B</th> <th>C</th> <th>D</th> <th>E</th> <th>H</th> </tr> </thead> <tbody> <tr> <td>2B / 2K / 2T</td> <td>0.8</td> <td>6.7</td> <td>60°</td> <td>30°</td> <td>15°</td> <td>3.5</td> </tr> </tbody> </table>	Series	Dimensions						A	B	C	D	E	H	2B / 2K / 2T	0.8	6.7	60°	30°	15°	3.5	<p>26PIN 32PIN</p>  <table border="1"> <thead> <tr> <th rowspan="2">Series</th> <th colspan="6">Dimensions</th> </tr> <tr> <th>A</th> <th>B</th> <th>C</th> <th>D</th> <th>E</th> <th>H</th> </tr> </thead> <tbody> <tr> <td>26pin</td> <td>0.6</td> <td>7</td> <td>120°</td> <td>40°</td> <td>25°</td> <td>4.2</td> </tr> <tr> <td>32pin</td> <td>0.6</td> <td>7</td> <td>72°</td> <td>36°</td> <td>21.11°</td> <td>2.2</td> </tr> </tbody> </table>	Series	Dimensions						A	B	C	D	E	H	26pin	0.6	7	120°	40°	25°	4.2	32pin	0.6	7	72°	36°	21.11°	2.2
Series		Dimensions																																														
	A	B	C	D	E	H																																										
2B / 2K / 2T	0.8	6.7	60°	30°	15°	3.5																																										
Series	Dimensions																																															
	A	B	C	D	E	H																																										
26pin	0.6	7	120°	40°	25°	4.2																																										
32pin	0.6	7	72°	36°	21.11°	2.2																																										

Appendix

B Series

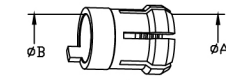

E Collect & Back nut Type

Collet Type	Size	Collet Code					 Standard Nut	 Nut with bend relief
			Collet		CableØ			
			ØA	ØB	min.	max.		
D	00	22	2.2		1.4	2.2	●	●
		27	2.7		>2.2	2.7	●	●
		35	3.5	2.8	>2.7	3.5	●	●
	0B	21	2.1		1.4	2.2	●	●
		31	3.1		>2.2	3.2	●	●
		42	4.2		>3.2	4.2	●	●
		52	5.2	4.7	>4.2	5.2	●	●
		56	5.6	4.7	>5.2	5.6	●	●
	1B	42	4.2		3.1	4.2	●	●
		52	5.2		>4.2	5.2	●	●
		62	6.2		>5.2	6.2	●	●
		72	7.2	6.2	>6.2	7.2	●	●
		76	7.6	6.9	>7.2	7.6	●	●
	2B	42	4.2		>3.2	4.2	●	●
		52	5.2		>4.2	5.2	●	●
		62	6.2		>5.2	6.2	●	●
		72	7.2		>6.2	7.2	●	●
		82	8.2		>7.2	8.2	●	●
		92	9.2	8.6	>8.2	9.2	●	●
		99	9.9	8.6	>9.2	9.9	●	●

Appendix

T Series

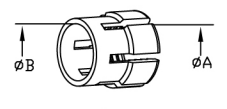

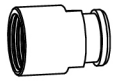
E Collect & Back nut Type

Collect Type	Size	Collect Code						
			Collect Ø (mm)		Cable Ø (mm)			
			ØA	Min.	Max.			
D	TT	27	2.6	2.4	2.6	●	●	
		31	3.0	2.7	3.0	●	●	
	OT	10	1.2	1.0	1.2	●	●	
		20	2.0	1.6	2.0	●	●	
		30	3.0	2.6	3.0	●	●	
		40	4.0	3.6	4.0	●	●	
		50	5.0	4.6	5.0	●	●	
	1T	60	6.0	5.6	6.0	●	●	
		20	2.0	1.6	2.0	●	●	
		30	3.0	2.6	3.0	●	●	
		40	4.0	3.6	4.0	●	●	
		50	5.0	4.6	5.0	●	●	
	2T	60	6.0	5.6	6.0	●	●	
		70	7.0	6.6	7.0	●	●	
		80	8.0	7.6	8.0	●	●	
		20	2.0	1.6	2.0	●	●	
		30	3.0	2.6	3.0	●	●	
		40	4.0	3.6	4.0	●	●	
		50	5.0	4.16	5.0	●	●	
	60	6.0	5.6	6.0	●	●		
70	7.0	6.6	7.0	●	●			
80	8.0	7.6	8.0	●	●			
90	9.0	8.6	9.0	●	●			

Appendix

K Series

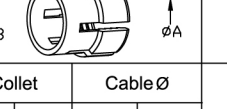
E Collect & Back nut Type

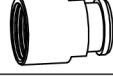
Collet Type	Size	Collet Code						
			Collet		Cable Ø			
			ØA	ØB	min.	max.		
C	OK	10	1.6		1.0	1.2	●	●
		15	1.6		1.3	1.5	●	●
		20	2.1		1.6	2.0	●	●
		25	3.1		2.1	2.5	●	●
		30	3.1		2.6	3.0	●	●
		35	4.2	4.2	3.1	3.5	●	●
		40	4.2	4.2	3.6	4.0	●	●
		45	5.2	5.2	4.1	4.5	●	●
		50	5.2	5.2	4.6	5.0	●	●
		1K	15	1.6		1.3	1.5	●
	20		2.2		1.6	2.0	●	●
	25		3.2		2.1	2.5	●	●
	30		3.2		2.6	3.0	●	●
	40		4.2		3.6	4.0	●	●
	45		5.2		4.1	4.5	●	●
	50		5.2		4.6	5.0	●	●
	55		6.2	6.2	5.1	5.5	●	●
	60		6.2	6.2	5.6	6.0	●	●
	65		7.2	6.7	6.1	6.5	●	●
	2K	15	2.2		1.3	1.5	●	●
		20	2.2		1.6	2.0	●	●
		25	3.2		2.1	2.5	●	●
		30	3.2		2.6	3.0	●	●
		35	4.2		3.1	3.5	●	●
		40	4.2		3.6	4.0	●	●
		45	5.2		4.1	4.5	●	●
		50	5.2		4.6	5.0	●	●
		55	6.2		5.1	5.5	●	●
		60	6.2		5.6	6.0	●	●
	65	7.2		6.1	6.5	●	●	
70	7.2		6.6	7.0	●	●		
75	8.2	8.2	7.1	7.5	●	●		
80	8.2	8.2	7.6	8.0	●	●		
85	9.2	8.6	8.1	8.5	●	●		